

# AVX Chip Inductors



Version 18.5



## **LCCM SERIES – CHIP COMMON MODE FILTER**

<b>Features</b> .....	<b>2</b>
<b>Applications</b> .....	<b>2</b>
<b>Construction</b> .....	<b>2</b>
<b>Dimensions</b> .....	<b>2</b>
<b>How to Order</b> .....	<b>2</b>
<b>Electrical Characteristics</b> .....	<b>3</b>
<b>Characteristics – Impedance vs. Frequency</b> .....	<b>4-5</b>
<b>Environmental Characteristics</b> .....	<b>6</b>
<b>Packaging</b> .....	<b>7</b>

## **LCWC SERIES – WIRE WOUND CHIP INDUCTORS**

<b>Features</b> .....	<b>8</b>
<b>Applications</b> .....	<b>8</b>
<b>Construction</b> .....	<b>8</b>
<b>Color Coding</b> .....	<b>8</b>
<b>Dimensions</b> .....	<b>8</b>
<b>How to Order</b> .....	<b>9</b>
<b>Electrical Specifications</b> .....	<b>9-14</b>
<b>Environmental Characteristics</b> .....	<b>15</b>
<b>Packaging</b> .....	<b>16</b>

## **LCWF SERIES – WIRE WOUND CHIP INDUCTORS (FERRITE)**

<b>Features</b> .....	<b>17</b>
<b>Applications</b> .....	<b>17</b>
<b>Construction</b> .....	<b>17</b>
<b>Dimensions</b> .....	<b>17</b>
<b>Color Coding</b> .....	<b>18</b>
<b>How to Order</b> .....	<b>18</b>
<b>Electrical Specifications</b> .....	<b>18-26</b>
<b>Environmental Characteristics</b> .....	<b>27</b>
<b>Packaging</b> .....	<b>28</b>

NOTICE: Specifications are subject to change without notice. Contact your nearest AVX Sales Office for the latest specifications. All statements, information and data given herein are believed to be accurate and reliable, but are presented without guarantee, warranty, or responsibility of any kind, expressed or implied. Statements or suggestions concerning possible use of our products are made without representation or warranty that any such use is free of patent infringement and are not recommendations to infringe any patent. The user should not assume that all safety measures are indicated or that other measures may not be required. Specifications are typical and may not apply to all applications.

## LCCM Series – Chip Common Mode Filter

### FEATURES

- Small wire wound chip inductor with ferrite core and 2 common mode lines.
- Highly effective in noise suppression
- High common-mode impedance at noise band and low differential mode impedance at signal band factor. There is almost no distortion in high-speed signals.
- Operating temperature -40°C ~ 85°C.

### APPLICATIONS

- EMI suppression for electronic devices.
- USB line in personal computers and peripherals.
- IEEE 1394 line for personal computers, DVC, and STB
- LCD Panels.
- Low-Voltage Differential Signal (LVDS)

### CONSTRUCTION

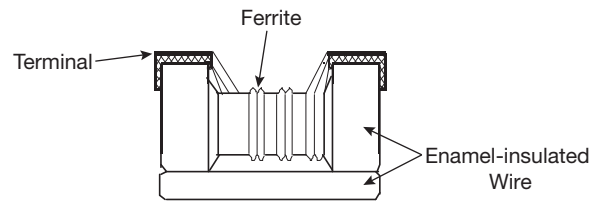

### DIMENSIONS

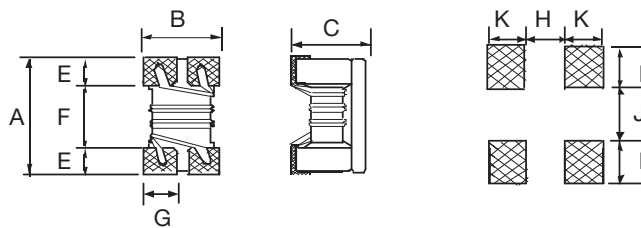

mm (inches)

Type	Size (inch)	A	B	C	E	F	G	H	I	J	K	Weight (g) (1000pcs)
LCCM0805	0805	2.00 ± 0.20 (0.079 ± 0.008)	1.20 ± 0.20 (0.047 ± 0.008)	1.20 ± 0.20 (0.047 ± 0.008)	0.45 (0.018)	1.20 (0.047)	0.40 (0.016)	0.80 (0.031)	0.40 (0.016)	0.40 (0.016)	0.90 (0.035)	19
LCCM1206	1206	3.20 ± 0.20 (0.126 ± 0.008)	1.60 ± 0.20 (0.063 ± 0.008)	1.80 ± 0.20 (0.071 ± 0.008)	0.60 (0.024)	2.00 (0.079)	0.60 (0.024)	1.60 (0.063)	0.60 (0.024)	0.40 (0.016)	1.05 (0.041)	53.3

### HOW TO ORDER

<b>LC</b>	<b>CM</b>	<b>0805</b>	<b>M</b>	<b>101</b>	<b>G</b>	<b>T</b>	<b>A</b>	<b>R</b>
<b>Family</b>	<b>Series</b>	<b>Size</b>	<b>Tolerance</b>	<b>Impedance</b>	<b>Style</b>	<b>Termination</b>	<b>Special</b>	<b>Packaging</b>
LC = Chip Inductor	CM = Common Mode	0805 1206	M = 20%	100 = 10 Ω 101 = 100 Ω 102 = 1000 Ω	G = Standard	T = Sn Plating	A = Standard	R = 7" Reel

### ELECTRICAL CHARACTERISTICS

#### 0805

Impedance (Ω)	Tolerance	Test Condition (MHz)	DCR (Ω) max.	IDC (mA) max.	Rated Voltage Vdc (V)	Withstanding Voltage Vdc (V)	Insulation Resistance (MΩ) min.
67	±20%	100	0.25	400	50	125	10
90	±20%	100	0.35	330	50	125	10
120	±20%	100	0.30	370	50	125	10
180	±20%	100	0.35	330	50	125	10
200	±20%	100	0.35	330	50	125	10
260	±20%	100	0.40	300	50	125	10
360	±20%	100	0.40	280	50	125	10
370	±20%	100	0.40	280	50	125	10

#### 1206

Impedance (Ω)	Tolerance	Test Condition (MHz)	DCR (Ω) max.	IDC (mA) max.	Rated Voltage Vdc (V)	Withstanding Voltage Vdc (V)	Insulation Resistance (MΩ) min.
90	±20%	100	0.30	370	50	125	10
160	±20%	100	0.40	340	50	125	10
260	±20%	100	0.50	310	50	125	10
600	±20%	100	0.80	260	50	125	10
1000	±20%	100	1.00	230	50	125	10
2200	±20%	100	1.20	200	50	125	10

### LCCM0805 CHARACTERISTICS – IMPEDANCE vs. FREQUENCY

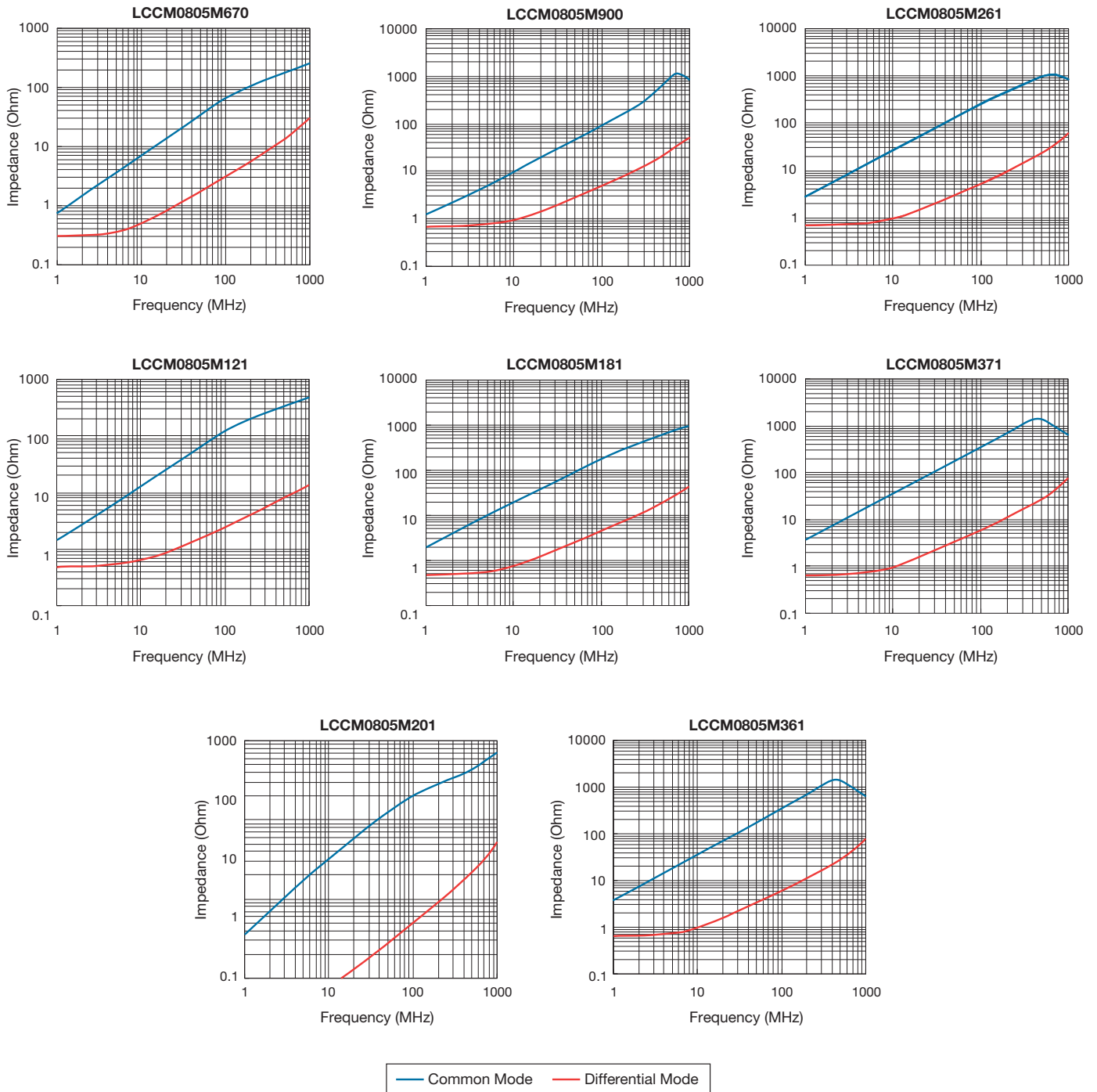

### LCCM1206 CHARACTERISTICS – IMPEDANCE vs. FREQUENCY

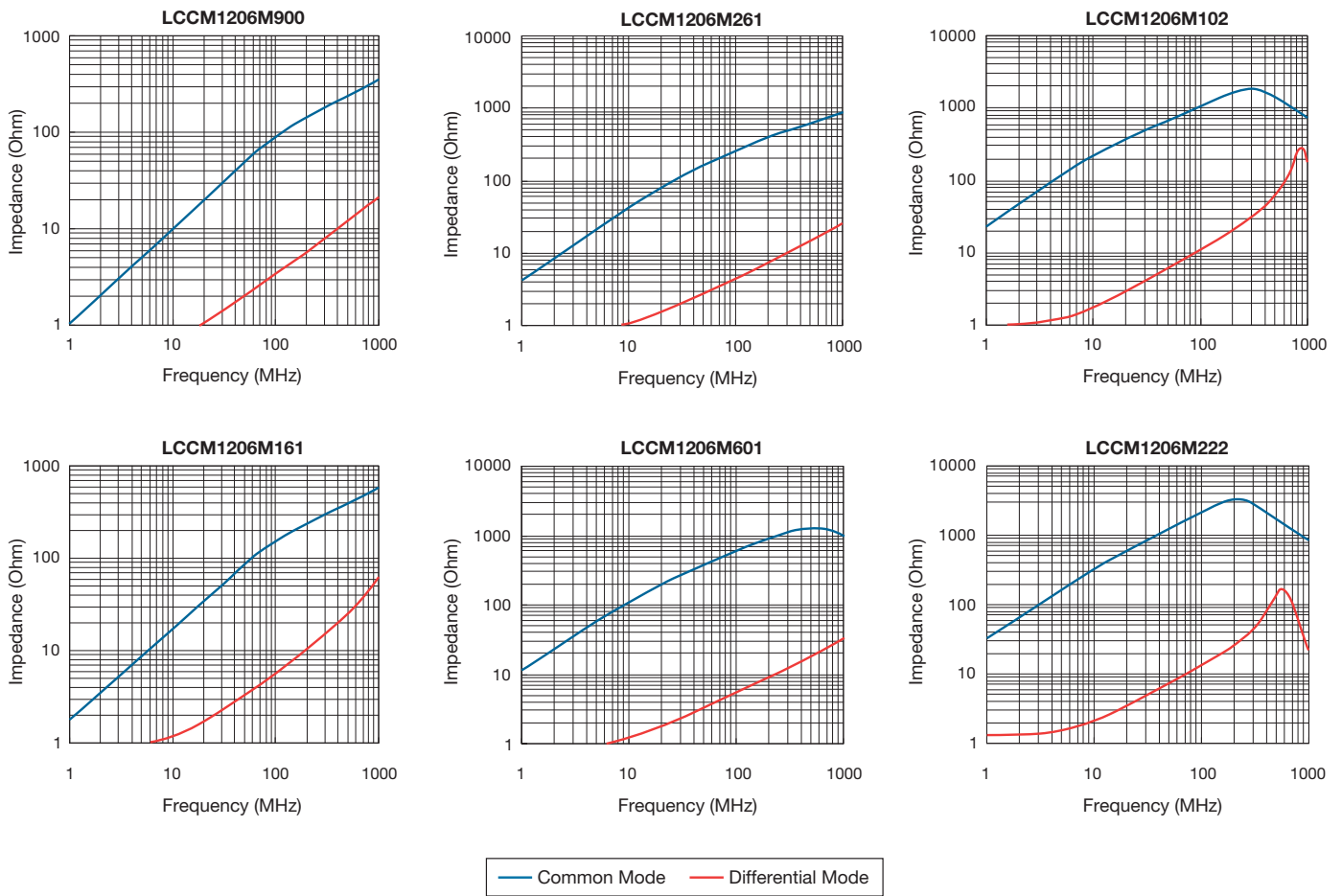

### ENVIRONMENTAL CHARACTERISTICS

#### ELECTRICAL PERFORMANCE TEST

Items	Requirement	Test Conditions   Test Methods
Impedance	Refer to standard electrical characteristic spec. Component should not be damaged	LCR Meter HP 4291B
DC Resistance DCR		Micro-Ohm meter (GOM-801G)
Withstand Voltage (VDC)		Test Voltage: 2.5 Times Rated Voltage Testing Time: 60 seconds Charge Current: 0.5mA
Rated Voltage (VDC)		Test Voltage: Rated Voltage Testing Time: 1 to 5 seconds Charge Current: 1mA
Insulation Resistance (I.R)		Charge Current: 1minute 10M ohm min.

#### MECHANICAL PERFORMANCE TEST

Items	Requirement	Test Conditions   Test Methods
Component Adhesion (Push Test)	Base: 0805 2 Lbs Cover: 0805 1 Lbs Base: 1206 4 Lbs Cover: 1206 2 Lbs	The component should be soldered ( $232^{\circ}\text{C} \pm 5^{\circ}\text{C}$ for 10 sec.) to tinned copper substrate Applied force gauge to the side of component It must withstand force of 2 or 4 pounds without failure of the component.
Drop	Component should not be damaged	Dropping chip by each side and corner. Drop 10 times in total Drop height: 100 cm Drop weight: 125 g
Solderability	The terminal should at least be 90% covered with solder	The component shall be dipped in a melted solder bath at $245 \pm 5^{\circ}\text{C}$ for 3 seconds
Vibration Test (Low Frequency)	Component should not be damaged	1. Amplitude: 1.5 m/m 2. Frequency: 10-55-10Hz (1min.) 3. Direction: X, Y, Z 4. Duration: 2 Hrs/X, Y, Z

#### MECHANICAL PERFORMANCE TEST

Items	Requirement	Test Conditions   Test Methods
Low Temperature Storage	Impedance change: Within $\pm 20\%$ Without distinct damage in appearance	1. Temp: $-40 \pm 2^{\circ}\text{C}$ 2. Time: $1000 \pm 48$ Hours 3. Component should be tested after 1 hour at room temperature
Thermal Shock		 <p>Total: 5 Cycles</p>
High Temperature Storage		1. Temp: $85 \pm 2^{\circ}\text{C}$ 2. Time: $1000 \pm 48$ Hours 3. Component should be tested after 1 hour at room temperature
Humidity		1. Temp: $40 \pm 2^{\circ}\text{C}$ 2. R.H. : 90 – 95% 3. Time: $48 \pm 2$ Hours
High Temperature Load Life		1. Temp: $85 \pm 2^{\circ}\text{C}$ 2. Time: $96 \pm 12$ Hours 3. Load: Allowed DC Current
Low Temperature Load Life	1. Temp: $-40 \pm 2^{\circ}\text{C}$ 2. Time: $96 \pm 12$ Hours 3. Load: Allowed DC Current	

### PACKAGING QUANTITY REAL SPECIFICATIONS

Type	Embossed Plastic Tape (EA)
LCCM0805	2,000
LCCM1206	2,000

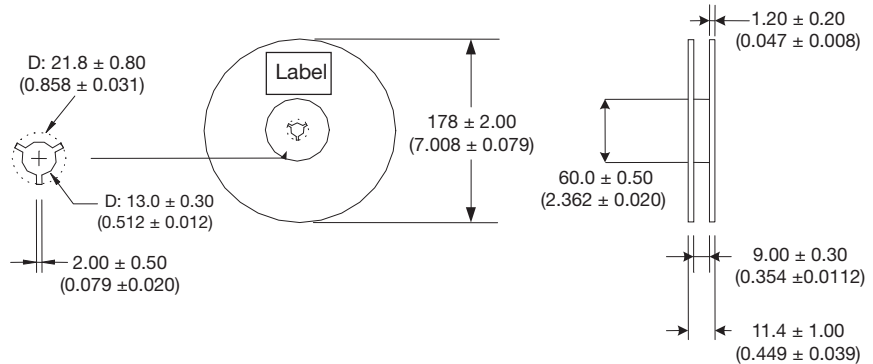

### EMBOSSED PLASTIC TAPE SPECIFICATIONS

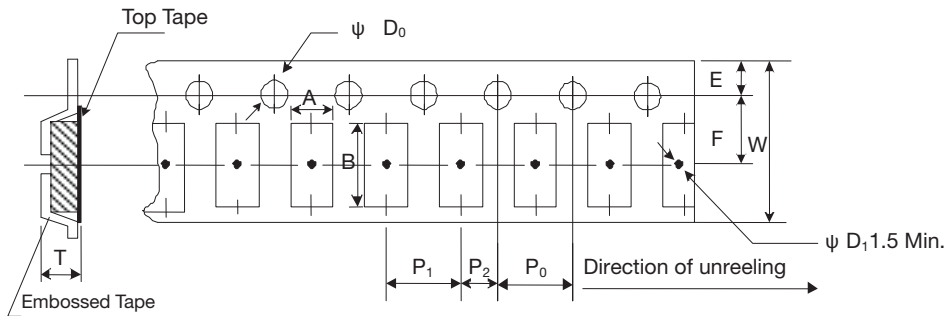

mm (inches)

Type	A	B	W	E	F	P <sub>0</sub>	P <sub>1</sub>	P <sub>2</sub>	ΦD <sub>0</sub>	T
LCCM0805	1.40 ± 0.10 (0.055 ± 0.004)	2.55 ± 0.05 (0.100 ± 0.002)	8.0 ± 0.20 (0.315 ± 0.008)	1.75 ± 0.10 (0.069 ± 0.004)	3.50 ± 0.10 (0.138 ± 0.004)	4.00 ± 0.10 (0.157 ± 0.004)	4.00 ± 0.10 (0.157 ± 0.004)	2.00 ± 0.10 (0.079 ± 0.004)	1.50 ± 0.10 (0.059 ± 0.004)	1.35 ± 0.10 (0.053 ± 0.004)
LCCM1206	1.90 ± 0.10 (0.075 ± 0.004)	3.50 ± 0.05 (0.138 ± 0.004)	8.0 ± 0.20 (0.315 ± 0.008)	1.75 ± 0.10 (0.069 ± 0.004)	3.5 ± 0.10 (0.138 ± 0.004)	4.00 ± 0.10 (0.157 ± 0.004)	4.00 ± 0.10 (0.157 ± 0.004)	2.00 ± 0.10 (0.079 ± 0.004)	1.50 ± 0.10 (0.059 ± 0.004)	2.10 ± 0.10 (0.083 ± 0.004)

### LEADER/TAPE

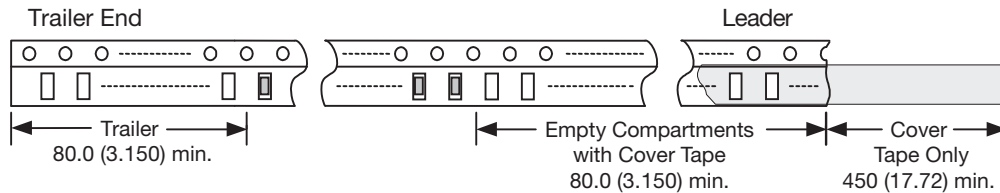

### PEEL-OFF FORCE

The force for tearing off cover tape is 0.05 - 0.69 (N) in the arrow direction at the following conditions:

Temperature: 5 - 35°C

Humidity: 45 - 85%

Atmospheric pressure: 860 - 1060hpa

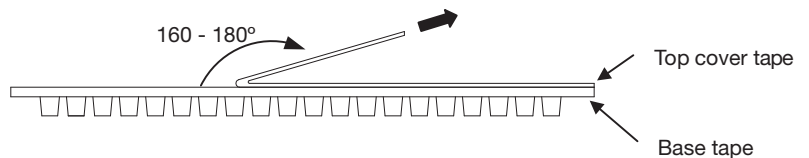



# Wire Wound Chip Inductor



## LCWC Series

### FEATURES

- Ceramic base provides high SRF
- Ultra-compact inductors provide high Q factors
- High current range available
- Miniature SMD chip inductor for fully automated assembly
- Outstanding endurance from Pull-up force, mechanical shock and pressure
- Tighter tolerance down to  $\pm 2\%$
- $-40^{\circ}\text{C}$  to  $+125^{\circ}\text{C}$

### APPLICATIONS

#### RF Products:

- Cellular Phone (CDMA/GSM/PHS)
- Cordless Phone (DECT/CT1CT2)
- Remote Control, Security System
- Wireless PDA
- Smart Phone
- WLL, Wireless LAN / Mouse / Keyboard / Earphone
- VCO, RF Module & Other Wireless Products
- Base Station, Repeater
- GPS Receiver



#### Broad Band Applications:

- CATV Filter, Tuner
- Cable Modem/ XDSL Tuner
- Set Top Box

#### IT Applications:

- USB 2.0
- IEEE 1394

### DIMENSIONS

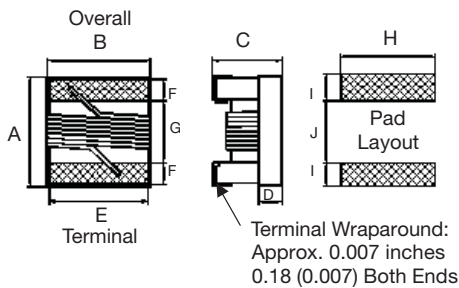

### CONSTRUCTION

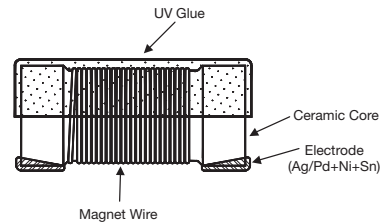

### COLOR CODING



### STANDARD

Type	Size (inch)	A Max.	B Max.	C Max.	D Ref.	E	F	G	H	I	J	Weight (g) (1000pcs)
0402	0402	1.27 (0.050)	0.76 (0.030)	0.61 (0.024)	0.15 (0.006)	0.51 (0.020)	0.23 (0.009)	0.56 (0.022)	0.66 (0.026)	0.50 (0.020)	0.46 (0.018)	0.8
0603	0603	1.80 (0.071)	1.12 (0.044)	1.02 (0.040)	0.38 (0.015)	0.76 (0.030)	0.33 (0.013)	0.86 (0.034)	1.02 (0.040)	0.64 (0.025)	0.64 (0.025)	3.46
0805	0805	2.29 (0.090)	1.73 (0.068)	1.52 (0.060)	0.51 (0.020)	1.27 (0.050)	0.44 (0.017)	1.02 (0.040)	1.78 (0.070)	1.02 (0.040)	0.76 (0.030)	12.13
1008	1008	2.92 (0.115)	2.79 (0.110)	2.13 (0.084)	0.65 (0.026)	2.03 (0.080)	0.51 (0.020)	1.52 (0.060)	2.54 (0.100)	1.02 (0.040)	1.27 (0.050)	30.73
1206	1206	3.45 (0.136)	1.90 (0.075)	1.40 (0.055)	0.50 (0.020)	1.60 (0.063)	0.50 (0.020)	2.20 (0.087)	1.93 (0.076)	1.02 (0.040)	1.78 (0.070)	40

### HIGH CURRENT/HIGH Q

Type	Size (inch)	A Max.	B Max.	C Max.	D Ref.	E	F	G	H	I	J
0603	0603	1.80 (0.071)	1.12 (0.044)	1.02 (0.040)	0.38 (0.015)	0.76 (0.030)	0.33 (0.013)	0.86 (0.034)	1.02 (0.040)	0.64 (0.025)	0.64 (0.025)
0805	0805	2.29 (0.090)	1.73 (0.068)	1.52 (0.060)	0.51 (0.020)	1.27 (0.050)	0.44 (0.017)	1.02 (0.040)	1.78 (0.070)	1.02 (0.040)	0.76 (0.030)
1008	1008	2.92 (0.115)	2.79 (0.110)	2.03 (0.080)	0.65 (0.026)	2.03 (0.080)	0.51 (0.020)	1.52 (0.060)	2.54 (0.100)	1.02 (0.040)	1.27 (0.050)

# Wire Wound Chip Inductor



## LCWC Series

### HOW TO ORDER

<b>LC</b>	<b>WC</b>	<b>0402</b>	<b>K</b>	<b>101</b>	<b>G</b>	<b>T</b>	<b>A</b>	<b>R</b>
Family	Series	Size	Tolerance	Inductance	Style	Termination	Special	Packaging
LC = Chip Inductor	WC = Wire Wound Ceramic	0402 0603 0805 1008 1206	G = 2% J = 5% K = 10%	3N9 = 3.9nH 39N = 39nH R39 = 390nH 3R9 = 3900nH 153 = 1500nH	G = Standard Q = High Q/ High Current	T = Sn Plating	A = Standard	R = 7" Reel

### STANDARD ELECTRICAL SPECIFICATIONS

0402										
Inductance (nH)	Tolerance	L Freq. (MHz)	Quality Factor Min.	SRF (GHz)	DCR (Ω) max.	IDC (mA) max.	900MHz		1.7GHz	
							L	Q	L	Q
1.0	±10%	250	16	12.70	0.045	1360	1.02	77	1.02	69
1.9	±10%	250	16	11.30	0.070	1040	1.72	68	1.74	82
2.0	±10%	250	16	11.10	0.070	1040	1.93	54	1.93	75
2.2	±10%	250	19	10.80	0.070	960	2.19	59	2.23	100
2.4	±10%	250	15	10.50	0.070	790	2.24	51	2.27	68
2.7	±10%	250	16	10.40	0.120	640	2.23	42	2.25	61
3.3	±10%	250	19	7.00	0.066	840	3.10	65	3.12	87
3.6	±5, ±10%	250	19	6.80	0.066	840	3.56	45	3.62	71
3.9	±5, ±10%	250	19	5.80	0.066	840	3.89	50	4.00	75
4.3	±5, ±10%	250	18	6.00	0.091	700	4.19	47	4.30	71
4.7	±5, ±10%	250	18	4.70	0.130	640	4.55	48	4.68	68
5.1	±5, ±10%	250	20	4.80	0.083	800	5.15	56	5.25	82
5.6	±5, ±10%	250	20	4.80	0.083	760	5.16	54	5.28	81
6.2	±5, ±10%	250	20	4.80	0.083	760	6.16	52	6.37	76
6.8	±5, ±10%	250	20	4.80	0.083	680	6.56	63	6.93	78
7.5	±5, ±10%	250	22	4.80	0.104	680	7.91	60	8.22	88
8.2	±5, ±10%	250	22	4.40	0.104	680	8.50	57	8.85	84
8.7	±5, ±10%	250	18	4.10	0.200	480	8.78	54	9.21	73
9.0	±5, ±10%	250	22	4.16	0.104	680	9.07	62	9.53	78
9.5	±5, ±10%	250	18	4.00	0.200	480	9.42	54	9.98	69
10	±2, ±5, ±10%	250	21	3.90	0.195	480	9.80	50	10.10	67
11	±2, ±5, ±10%	250	24	3.68	0.120	640	10.70	52	11.20	78
12	±2, ±5, ±10%	250	24	3.60	0.120	640	11.90	53	12.70	71
13	±2, ±5, ±10%	250	24	3.45	0.210	440	13.40	51	14.60	57
15	±2, ±5, ±10%	250	24	3.28	0.172	560	14.60	55	15.50	77
16	±2, ±5, ±10%	250	24	3.10	0.220	560	16.60	46	18.80	47
18	±2, ±5, ±10%	250	25	3.10	0.230	420	18.30	57	20.30	62
19	±2, ±5, ±10%	250	24	3.04	0.202	480	19.10	50	21.10	67
20	±2, ±5, ±10%	250	25	3.00	0.250	420	20.70	52	23.70	53
22	±2, ±5, ±10%	250	25	2.80	0.300	400	23.20	53	26.80	53
23	±2, ±5, ±10%	250	24	2.72	0.300	400	23.80	49	26.90	64
24	±2, ±5, ±10%	250	25	2.70	0.300	400	25.10	51	29.50	50
27	±2, ±5, ±10%	250	24	2.48	0.300	400	28.70	49	33.50	63
30	±2, ±5, ±10%	250	25	2.35	0.350	400	31.10	46	38.50	39
33	±2, ±5, ±10%	250	24	2.35	0.350	400	34.90	31	41.70	32
36	±2, ±5, ±10%	250	24	2.32	0.440	320	39.50	44	48.40	53
39	±2, ±5, ±10%	250	25	2.10	0.550	200	41.70	47	50.20	45
40	±2, ±5, ±10%	250	24	2.24	0.500	320	39.00	44	47.40	33
43	±2, ±5, ±10%	250	25	2.03	0.810	100	45.80	46	61.60	34
47	±2, ±5, ±10%	250	25	2.10	0.830	150	50.00	38	55.80	37
51	±2, ±5, ±10%	250	25	1.75	0.820	100	50.40	47	59.40	37
56	±2, ±5, ±10%	250	25	1.76	0.970	100	57.40	49	72.40	40
68	±2, ±5, ±10%	250	22	1.62	1.120	100	69.60	45	83.40	38

# Wire Wound Chip Inductor



## LCWC Series

### 0603

Inductance (nH)	Tolerance	L Freq. (MHz)	Quality Factor Min.	SRF (GHz)	DCR ( $\Omega$ ) max.	IDC (mA) max.	900MHz		1.7GHz		Color Code
							L	Q	L	Q	
1.6	$\pm 5, \pm 10\%$	250	24	12.5	0.030	700	1.53	35	1.58	55	Blue
1.8	$\pm 5, \pm 10\%$	250	16	12.5	0.045	700	1.63	35	1.66	50	Black
2.2	$\pm 5, \pm 10\%$	250	15	6.00	0.100	700	2.18	41	2.20	64	White
2.3	$\pm 5, \pm 10\%$	250	16	>4.00	0.140	700	2.32	32	2.35	40	Yellow
3.3	$\pm 2, \pm 5, \pm 10\%$	250	22	>6.00	0.080	700	3.35	47	3.40	65	Red
3.6	$\pm 2, \pm 5, \pm 10\%$	250	22	5.80	0.063	700	3.53	49	3.58	65	Violet
3.9	$\pm 2, \pm 5, \pm 10\%$	250	22	>6.00	0.080	700	3.95	49	3.96	67	Brown
4.3	$\pm 2, \pm 5, \pm 10\%$	250	22	5.80	0.063	700	4.32	49	4.43	67	Orange
4.5	$\pm 2, \pm 5, \pm 10\%$	250	20	5.80	0.120	700	4.74	55	4.87	92	Gray
4.7	$\pm 2, \pm 5, \pm 10\%$	250	25	5.80	0.120	700	4.65	53	4.80	67	Violet
5.1	$\pm 2, \pm 5, \pm 10\%$	250	20	5.80	0.160	700	5.13	47	5.36	56	Green
5.6	$\pm 2, \pm 5, \pm 10\%$	250	20	5.80	0.170	700	5.53	56	5.86	77	Yellow
6.2	$\pm 2, \pm 5, \pm 10\%$	250	25	5.80	0.110	700	6.28	60	6.40	85	Black
6.3	$\pm 2, \pm 5, \pm 10\%$	250	25	5.80	0.110	700	6.67	41	6.86	61	Black
6.8	$\pm 2, \pm 5, \pm 10\%$	250	27	5.80	0.110	700	6.75	60	7.10	81	Red
7.5	$\pm 2, \pm 5, \pm 10\%$	250	28	4.80	0.106	700	7.70	60	7.82	65	Brown
8.2	$\pm 2, \pm 5, \pm 10\%$	250	27	4.80	0.110	700	8.25	64	8.40	81	Green
8.7	$\pm 2, \pm 5, \pm 10\%$	250	28	4.80	0.109	700	8.86	62	9.32	58	Yellow
9.1	$\pm 2, \pm 5, \pm 10\%$	250	35	4.80	0.130	700	9.20	70	9.70	80	Black
9.5	$\pm 2, \pm 5, \pm 10\%$	250	28	5.40	0.135	700	9.70	59	9.92	61	Blue
10	$\pm 2, \pm 5, \pm 10\%$	250	31	4.80	0.130	700	10.0	66	10.6	83	Orange
11	$\pm 2, \pm 5, \pm 10\%$	250	31	4.00	0.086	700	11.3	53	12.1	56	Gray
12	$\pm 2, \pm 5, \pm 10\%$	250	35	4.00	0.130	700	12.3	72	13.5	83	Yellow
15	$\pm 2, \pm 5, \pm 10\%$	250	35	4.00	0.170	700	15.4	64	16.8	89	Green
16	$\pm 2, \pm 5, \pm 10\%$	250	35	3.30	0.110	700	16.5	55	18.0	52	White
17	$\pm 2, \pm 5, \pm 10\%$	250	35	3.20	0.170	700	17.6	56	19.4	44	Red
18	$\pm 2, \pm 5, \pm 10\%$	250	35	3.10	0.170	700	18.7	70	21.4	69	Blue
20	$\pm 2, \pm 5, \pm 10\%$	250	40	3.00	0.190	700	20.7	80	23.5	30	Green
22	$\pm 2, \pm 5, \pm 10\%$	250	38	3.00	0.190	700	22.8	73	26.1	71	Violet
23	$\pm 2, \pm 5, \pm 10\%$	250	38	2.85	0.190	700	24.1	71	28.0	71	Orange
24	$\pm 2, \pm 5, \pm 10\%$	250	38	2.80	0.130	700	25.7	45	30.9	40	Black
27	$\pm 2, \pm 5, \pm 10\%$	250	40	2.80	0.220	600	29.2	74	34.6	65	Gray
30	$\pm 2, \pm 5, \pm 10\%$	250	40	2.80	0.150	600	31.4	47	39.8	28	Brown
33	$\pm 2, \pm 5, \pm 10\%$	250	40	2.30	0.220	600	36.0	67	49.5	42	White
36	$\pm 2, \pm 5, \pm 10\%$	250	37	2.30	0.250	600	39.1	47	48.9	24	Red
39	$\pm 2, \pm 5, \pm 10\%$	250	40	2.20	0.250	600	42.7	60	60.2	40	Black
43	$\pm 2, \pm 5, \pm 10\%$	200	38	2.00	0.280	600	46.9	44	60.3	21	Orange
47	$\pm 2, \pm 5, \pm 10\%$	200	38	2.00	0.280	600	52.2	62	77.2	35	Brown
51	$\pm 2, \pm 5, \pm 10\%$	200	38	1.90	0.280	600	55.5	69	82.2	34	Blue
56	$\pm 2, \pm 5, \pm 10\%$	200	38	1.90	0.310	600	62.5	56	97.0	26	Red
62	$\pm 2, \pm 5, \pm 10\%$	200	37	1.80	0.340	600	68.0	40	110	10	Gray
68	$\pm 2, \pm 5, \pm 10\%$	200	37	1.70	0.340	600	80.5	54	168	21	Orange
72	$\pm 2, \pm 5, \pm 10\%$	150	34	1.70	0.490	600	82.0	53	135	20	Yellow
82	$\pm 2, \pm 5, \pm 10\%$	150	34	1.70	0.540	400	96.2	54	177	21	Green
91	$\pm 2, \pm 5, \pm 10\%$	150	30	1.70	0.500	400	110.0	50	416.4	6	Brown
100	$\pm 2, \pm 5, \pm 10\%$	150	34	1.40	0.580	400	124.0	49	319.5	13	Blue
110	$\pm 2, \pm 5, \pm 10\%$	150	32	1.35	0.610	300	138.0	43	342.7	15	Violet
120	$\pm 2, \pm 5, \pm 10\%$	150	32	1.30	0.650	300	166.0	39	529.3	8	Gray
130	$\pm 2, \pm 5, \pm 10\%$	150	30	1.40	0.720	300	185.0	60	-	-	White
140	$\pm 2, \pm 5, \pm 10\%$	100	28	1.30	0.870	280	190.0	80	-	-	Blue
150	$\pm 2, \pm 5, \pm 10\%$	100	28	1.30	0.950	280	230.0	25	-	-	White
160	$\pm 2, \pm 5, \pm 10\%$	100	25	1.30	1.400	280	215.0	20	-	-	Yellow
180	$\pm 2, \pm 5, \pm 10\%$	100	25	1.25	1.400	250	305.0	22	-	-	Black
220	$\pm 2, \pm 5, \pm 10\%$	100	25	1.20	1.600	250	377.0	21	-	-	Brown
260	$\pm 2, \pm 5, \pm 10\%$	100	25	1.00	2.000	200	469.0	21	-	-	Violet
270	$\pm 2, \pm 5, \pm 10\%$	100	25	0.90	2.100	200	523.0	19	-	-	Red
280	$\pm 2, \pm 5, \pm 10\%$	100	25	1.00	2.400	100	524.0	18	-	-	Green
300	$\pm 2, \pm 5, \pm 10\%$	100	25	0.75	2.500	150	539.7	21	-	-	Orange
330	$\pm 2, \pm 5, \pm 10\%$	100	25	0.90	3.800	100	680.4	20	-	-	Blue
390	$\pm 2, \pm 5, \pm 10\%$	100	25	0.90	4.350	100	734.5	29	-	-	Yellow
470	$\pm 2, \pm 5, \pm 10\%$	100	23	0.60	3.600	80	-	-	-	-	White



# Wire Wound Chip Inductor



## LCWC Series

### 0805

Inductance (nH)	Tolerance	L Freq. (MHz)	Quality Factor min.	SRF (GHz) min.	DCR ( $\Omega$ ) max.	IDC (mA) max.	Color Code
2.7	$\pm 5, \pm 10\%$	250	80 @ 1500MHz	7.900	0.06	800	Brown
2.8	$\pm 5, \pm 10\%$	250	80 @ 1500MHz	7.900	0.06	800	Gray
3.0	$\pm 5, \pm 10\%$	250	65 @ 1500MHz	7.900	0.06	800	White
3.3	$\pm 5, \pm 10\%$	250	50 @ 1500MHz	6.000	0.08	600	Black
5.6	$\pm 5, \pm 10\%$	250	65 @ 1000MHz	5.500	0.08	600	Orange
6.2	$\pm 5, \pm 10\%$	250	50 @ 1000MHz	5.500	0.11	600	Green
6.8	$\pm 5, \pm 10\%$	250	50 @ 1000MHz	5.500	0.11	600	Brown
7.5	$\pm 5, \pm 10\%$	250	50 @ 1000MHz	4.500	0.14	600	Green
8.2	$\pm 5, \pm 10\%$	250	50 @ 1000MHz	4.700	0.12	600	Red
8.7	$\pm 5, \pm 10\%$	250	50 @ 1000MHz	4.000	0.21	400	White
10	$\pm 2, \pm 5, \pm 10\%$	250	60 @ 500MHz	4.200	0.10	600	Blue
12	$\pm 2, \pm 5, \pm 10\%$	250	50 @ 500MHz	4.000	0.15	600	Orange
15	$\pm 2, \pm 5, \pm 10\%$	250	50 @ 500MHz	3.400	0.17	600	Yellow
18	$\pm 2, \pm 5, \pm 10\%$	250	50 @ 500MHz	3.300	0.20	600	Green
22	$\pm 2, \pm 5, \pm 10\%$	250	55 @ 500MHz	2.600	0.22	500	Blue
24	$\pm 2, \pm 5, \pm 10\%$	250	50 @ 500MHz	2.000	0.22	500	Gray
27	$\pm 2, \pm 5, \pm 10\%$	250	55 @ 500MHz	2.500	0.25	500	Violet
33	$\pm 2, \pm 5, \pm 10\%$	250	60 @ 500MHz	2.050	0.27	500	Gray
36	$\pm 2, \pm 5, \pm 10\%$	250	55 @ 500MHz	1.700	0.27	500	Orange
39	$\pm 2, \pm 5, \pm 10\%$	250	60 @ 500MHz	2.000	0.29	500	White
43	$\pm 2, \pm 5, \pm 10\%$	200	60 @ 500MHz	1.650	0.34	500	Yellow
47	$\pm 2, \pm 5, \pm 10\%$	200	60 @ 500MHz	1.650	0.31	500	Black
56	$\pm 2, \pm 5, \pm 10\%$	200	60 @ 500MHz	1.550	0.34	500	Brown
68	$\pm 2, \pm 5, \pm 10\%$	200	60 @ 500MHz	1.450	0.38	500	Red
72	$\pm 2, \pm 5, \pm 10\%$	150	65 @ 500MHz	1.400	0.40	500	Green
82	$\pm 2, \pm 5, \pm 10\%$	150	65 @ 500MHz	1.300	0.42	400	Orange
91	$\pm 2, \pm 5, \pm 10\%$	150	65 @ 500MHz	1.200	0.48	400	Black
100	$\pm 2, \pm 5, \pm 10\%$	150	65 @ 500MHz	1.200	0.46	400	Yellow
110	$\pm 2, \pm 5, \pm 10\%$	150	50 @ 250MHz	1.000	0.48	400	Brown
120	$\pm 2, \pm 5, \pm 10\%$	150	50 @ 250MHz	1.100	0.51	400	Green
150	$\pm 2, \pm 5, \pm 10\%$	100	50 @ 250MHz	0.920	0.56	400	Blue
180	$\pm 2, \pm 5, \pm 10\%$	100	50 @ 250MHz	0.870	0.64	400	Violet
200	$\pm 2, \pm 5, \pm 10\%$	100	50 @ 250MHz	0.860	0.66	400	Orange
220	$\pm 2, \pm 5, \pm 10\%$	100	50 @ 250MHz	0.850	0.70	400	Gray
240	$\pm 2, \pm 5, \pm 10\%$	100	44 @ 250MHz	0.690	1.00	350	Red
250	$\pm 2, \pm 5, \pm 10\%$	100	50 @ 250MHz	0.680	1.00	350	Green
270	$\pm 2, \pm 5, \pm 10\%$	100	48 @ 250MHz	0.650	1.00	350	White
300	$\pm 2, \pm 5, \pm 10\%$	100	48 @ 250MHz	0.620	1.20	330	Yellow
330	$\pm 2, \pm 5, \pm 10\%$	100	48 @ 250MHz	0.600	1.40	310	Black
360	$\pm 2, \pm 5, \pm 10\%$	100	48 @ 250MHz	0.580	1.45	300	Green
390	$\pm 2, \pm 5, \pm 10\%$	100	48 @ 250MHz	0.560	1.50	290	Brown
430	$\pm 2, \pm 5, \pm 10\%$	50	33 @ 100MHz	0.430	1.70	230	Blue
470	$\pm 2, \pm 5, \pm 10\%$	50	33 @ 100MHz	0.375	1.70	250	Red
560	$\pm 2, \pm 5, \pm 10\%$	25	23 @ 50MHz	0.340	1.90	230	Orange
600	$\pm 2, \pm 5, \pm 10\%$	25	23 @ 50MHz	0.260	1.60	450	White
620	$\pm 2, \pm 5, \pm 10\%$	25	23 @ 50MHz	0.220	2.20	210	Yellow
680	$\pm 2, \pm 5, \pm 10\%$	25	23 @ 50MHz	0.200	2.20	190	Green
750	$\pm 2, \pm 5, \pm 10\%$	25	23 @ 50MHz	0.200	2.30	180	Blue
820	$\pm 2, \pm 5, \pm 10\%$	25	23 @ 50MHz	0.200	2.35	180	Violet
1000	$\pm 2, \pm 5, \pm 10\%$	25	20 @ 50MHz	0.100	2.50	170	Gray
1200	$\pm 2, \pm 5, \pm 10\%$	7.9	18 @ 25MHz	0.100	2.50	170	White
1500	$\pm 2, \pm 5, \pm 10\%$	7.9	16 @ 25MHz	0.100	2.50	170	Black
1800	$\pm 2, \pm 5, \pm 10\%$	7.9	16 @ 7.9MHz	0.080	2.50	170	Brown
2200	$\pm 2, \pm 5, \pm 10\%$	7.9	16 @ 7.9MHz	0.060	2.70	160	Red
2700	$\pm 2, \pm 5, \pm 10\%$	7.9	16 @ 7.9MHz	0.050	3.10	150	Orange
3300	$\pm 2, \pm 5, \pm 10\%$	7.9	15 @ 7.9MHz	0.040	4.40	90	Blue
4700	$\pm 2, \pm 5, \pm 10\%$	7.9	15 @ 7.9MHz	0.040	6.40	90	Green



# Wire Wound Chip Inductor



## LCWC Series

### 1008

Inductance (nH)	Tolerance	L Freq. (MHz)	Quality Factor min.	SRF (GHz) min.	DCR ( $\Omega$ ) max.	IDC (mA) max.	Color Code
*5.6	$\pm 5, \pm 10\%$	50	50 @ 1500MHz	4.000	0.15	1000	Black
*10	$\pm 2, \pm 5, \pm 10\%$	50	50 @ 500MHz	4.100	0.08	1000	Brown
*12	$\pm 2, \pm 5, \pm 10\%$	50	50 @ 500MHz	3.300	0.09	1000	Red
*15	$\pm 2, \pm 5, \pm 10\%$	50	50 @ 500MHz	2.500	0.11	1000	Orange
*18	$\pm 2, \pm 5, \pm 10\%$	50	50 @ 350MHz	2.400	0.12	1000	Yellow
*22	$\pm 2, \pm 5, \pm 10\%$	50	55 @ 350MHz	2.400	0.12	1000	Green
24	$\pm 2, \pm 5, \pm 10\%$	50	55 @ 350MHz	1.900	0.13	1000	Blue
*27	$\pm 2, \pm 5, \pm 10\%$	50	55 @ 350MHz	1.600	0.13	1000	Violet
*33	$\pm 2, \pm 5, \pm 10\%$	50	60 @ 350MHz	1.600	0.14	1000	Gray
36	$\pm 2, \pm 5, \pm 10\%$	50	60 @ 350MHz	1.600	0.15	1000	Orange
*39	$\pm 2, \pm 5, \pm 10\%$	50	60 @ 350MHz	1.500	0.15	1000	White
*47	$\pm 2, \pm 5, \pm 10\%$	50	65 @ 350MHz	1.500	0.16	1000	Black
*56	$\pm 2, \pm 5, \pm 10\%$	50	65 @ 350MHz	1.300	0.18	1000	Brown
*62	$\pm 2, \pm 5, \pm 10\%$	50	65 @ 350MHz	1.250	0.20	1000	Blue
*68	$\pm 2, \pm 5, \pm 10\%$	50	65 @ 350MHz	1.300	0.20	1000	Red
75	$\pm 2, \pm 5, \pm 10\%$	50	60 @ 350MHz	1.100	0.21	1000	White
*82	$\pm 2, \pm 5, \pm 10\%$	50	60 @ 350MHz	1.000	0.22	1000	Orange
91	$\pm 2, \pm 5, \pm 10\%$	50	50 @ 350MHz	1.000	0.45	1000	White
*100	$\pm 2, \pm 5, \pm 10\%$	25	60 @ 350MHz	1.000	0.56	650	Yellow
*120	$\pm 2, \pm 5, \pm 10\%$	25	60 @ 350MHz	0.950	0.63	650	Green
*150	$\pm 2, \pm 5, \pm 10\%$	25	45 @ 100MHz	0.850	0.70	800	Blue
*180	$\pm 2, \pm 5, \pm 10\%$	25	45 @ 100MHz	0.750	0.77	620	Violet
*220	$\pm 2, \pm 5, \pm 10\%$	25	45 @ 100MHz	0.700	0.84	500	Gray
*240	$\pm 2, \pm 5, \pm 10\%$	25	45 @ 100MHz	0.650	0.88	500	White
*270	$\pm 2, \pm 5, \pm 10\%$	25	45 @ 100MHz	0.600	0.91	690	Black
*300	$\pm 2, \pm 5, \pm 10\%$	25	45 @ 100MHz	0.585	1.00	450	Brown
*330	$\pm 2, \pm 5, \pm 10\%$	25	45 @ 100MHz	0.570	1.05	450	Red
*360	$\pm 2, \pm 5, \pm 10\%$	25	45 @ 100MHz	0.530	1.10	470	Orange
*390	$\pm 2, \pm 5, \pm 10\%$	25	45 @ 100MHz	0.500	1.12	630	Yellow
*430	$\pm 2, \pm 5, \pm 10\%$	25	45 @ 100MHz	0.480	1.15	470	Green
*470	$\pm 2, \pm 5, \pm 10\%$	25	45 @ 100MHz	0.450	1.19	470	Blue
*560	$\pm 2, \pm 5, \pm 10\%$	25	45 @ 100MHz	0.415	1.33	580	Violet
*620	$\pm 2, \pm 5, \pm 10\%$	25	45 @ 100MHz	0.375	1.40	300	Gray
*680	$\pm 2, \pm 5, \pm 10\%$	25	45 @ 100MHz	0.375	1.47	540	White
*750	$\pm 2, \pm 5, \pm 10\%$	25	45 @ 100MHz	0.360	1.54	360	Black
*820	$\pm 2, \pm 5, \pm 10\%$	25	45 @ 100MHz	0.350	1.61	400	Brown
*910	$\pm 2, \pm 5, \pm 10\%$	25	35 @ 50MHz	0.320	1.68	380	Red
*1000	$\pm 2, \pm 5, \pm 10\%$	25	35 @ 50MHz	0.290	1.75	370	Orange
*1200	$\pm 2, \pm 5, \pm 10\%$	7.9	35 @ 50MHz	0.250	2.00	310	Yellow
*1500	$\pm 2, \pm 5, \pm 10\%$	7.9	28 @ 50MHz	0.200	2.30	330	Green
*1800	$\pm 2, \pm 5, \pm 10\%$	7.9	28 @ 50MHz	0.160	2.60	300	Blue
*2200	$\pm 2, \pm 5, \pm 10\%$	7.9	28 @ 50MHz	0.160	2.80	280	Violet
*2700	$\pm 2, \pm 5, \pm 10\%$	7.9	22 @ 25MHz	0.140	3.20	290	Gray
*3300	$\pm 2, \pm 5, \pm 10\%$	7.9	22 @ 25MHz	0.110	3.40	290	White
*3900	$\pm 2, \pm 5, \pm 10\%$	7.9	18 @ 25MHz	0.100	3.60	260	Black
*4700	$\pm 2, \pm 5, \pm 10\%$	7.9	18 @ 25MHz	0.090	4.00	260	Brown
5600	$\pm 2, \pm 5, \pm 10\%$	7.9	16 @ 7.96MHz	0.020	4.00	240	Red
6800	$\pm 2, \pm 5, \pm 10\%$	7.9	15 @ 7.96MHz	0.040	4.90	200	Orange
8200	$\pm 2, \pm 5, \pm 10\%$	7.9	15 @ 7.96MHz	0.025	6.00	170	Yellow
10000	$\pm 2, \pm 5, \pm 10\%$	2.52	15 @ 7.96MHz	0.020	9.00	150	Green
12000	$\pm 2, \pm 5, \pm 10\%$	2.52	15 @ 7.96MHz	0.018	10.5	130	Blue
15000	$\pm 2, \pm 5, \pm 10\%$	2.52	15 @ 7.96MHz	0.015	11.5	120	Violet

\* Test Method/Instrument: Network/Spectrum Analyzer



# Wire Wound Chip Inductor



## LCWC Series

### 1206

Inductance (nH)	Tolerance	L Freq. (MHz)	Quality Factor min.	SRF (GHz) min.	DCR ( $\Omega$ ) max.	IDC (mA) max.	Color Code
6.8	$\pm 5, \pm 10\%$	100	30 @ 300MHz	5.50	0.07	1000	Brown
10	$\pm 5, \pm 10\%$	100	40 @ 300MHz	4.00	0.08	1000	Red
12	$\pm 5, \pm 10\%$	100	40 @ 300MHz	3.20	0.08	1000	Orange
15	$\pm 5, \pm 10\%$	100	40 @ 300MHz	3.20	0.10	1000	Yellow
18	$\pm 5, \pm 10\%$	100	50 @ 300MHz	2.80	0.10	1000	Green
22	$\pm 5, \pm 10\%$	100	50 @ 300MHz	2.20	0.10	1000	Blue
24	$\pm 5, \pm 10\%$	100	50 @ 300MHz	2.00	0.10	1000	Red
27	$\pm 2, \pm 5, \pm 10\%$	100	50 @ 300MHz	1.80	0.11	1000	Violet
33	$\pm 2, \pm 5, \pm 10\%$	100	55 @ 300MHz	1.80	0.11	1000	Gray
39	$\pm 2, \pm 5, \pm 10\%$	100	55 @ 300MHz	1.80	0.12	1000	White
47	$\pm 2, \pm 5, \pm 10\%$	100	55 @ 300MHz	1.50	0.13	1000	Black
56	$\pm 2, \pm 5, \pm 10\%$	100	55 @ 300MHz	1.45	0.14	1000	Brown
62	$\pm 2, \pm 5, \pm 10\%$	100	55 @ 300MHz	1.20	0.20	1000	Violet
68	$\pm 2, \pm 5, \pm 10\%$	100	55 @ 300MHz	1.20	0.26	950	Red
82	$\pm 2, \pm 5, \pm 10\%$	100	55 @ 300MHz	1.20	0.21	920	Orange
91	$\pm 2, \pm 5, \pm 10\%$	100	55 @ 300MHz	1.10	0.24	900	White
100	$\pm 2, \pm 5, \pm 10\%$	100	55 @ 300MHz	1.10	0.26	850	Yellow
120	$\pm 2, \pm 5, \pm 10\%$	100	55 @ 300MHz	0.75	0.26	800	Green
150	$\pm 2, \pm 5, \pm 10\%$	100	60 @ 300MHz	0.95	0.31	750	Blue
180	$\pm 2, \pm 5, \pm 10\%$	50	55 @ 300MHz	0.90	0.43	700	Violet
220	$\pm 2, \pm 5, \pm 10\%$	50	55 @ 300MHz	0.76	0.50	670	Gray
270	$\pm 2, \pm 5, \pm 10\%$	50	55 @ 300MHz	0.74	0.56	630	White
300	$\pm 2, \pm 5, \pm 10\%$	50	50 @ 150MHz	0.68	0.60	600	Green
330	$\pm 2, \pm 5, \pm 10\%$	50	45 @ 150MHz	0.65	0.62	590	Black
360	$\pm 2, \pm 5, \pm 10\%$	50	45 @ 150MHz	0.60	0.65	550	Blue
390	$\pm 2, \pm 5, \pm 10\%$	50	45 @ 150MHz	0.60	0.75	530	Brown
470	$\pm 2, \pm 5, \pm 10\%$	50	45 @ 150MHz	0.55	1.30	490	Red
560	$\pm 2, \pm 5, \pm 10\%$	35	45 @ 150MHz	0.47	1.34	460	Orange
620	$\pm 2, \pm 5, \pm 10\%$	35	45 @ 150MHz	0.47	1.58	460	Gray
680	$\pm 2, \pm 5, \pm 10\%$	35	45 @ 150MHz	0.45	1.58	430	Yellow
750	$\pm 2, \pm 5, \pm 10\%$	35	45 @ 150MHz	0.44	2.25	320	White
820	$\pm 2, \pm 5, \pm 10\%$	35	45 @ 150MHz	0.42	1.82	400	Green
910	$\pm 2, \pm 5, \pm 10\%$	35	45 @ 150MHz	0.41	2.95	310	Green
1000	$\pm 2, \pm 5, \pm 10\%$	35	45 @ 150MHz	0.40	2.80	320	Blue
1200	$\pm 2, \pm 5, \pm 10\%$	35	45 @ 150MHz	0.38	3.20	300	Violet

# Wire Wound Chip Inductor



## LCWC Series

### HIGH CURRENT ELECTRICAL SPECIFICATIONS

#### 0603

Inductance (nH)	Tolerance	L Freq. (MHz)	Quality Factor min.	SRF (GHz) min.	DCR ( $\Omega$ ) max.	IDC (mA) max.	Color Code
1.6	$\pm 5, \pm 10\%$	250	24	12.50	0.030	2400	Black
3.6	$\pm 5, \pm 10\%$	250	24	5.90	0.048	2300	Brown
3.9	$\pm 5, \pm 10\%$	250	25	5.90	0.054	2200	Red
6.8	$\pm 5, \pm 10\%$	250	35	5.80	0.054	2100	Orange
7.5	$\pm 5, \pm 10\%$	250	38	3.70	0.059	2100	Yellow
8.2	$\pm 5, \pm 10\%$	250	38	3.70	0.060	2000	White
10	$\pm 2, \pm 5, \pm 10\%$	250	38	3.70	0.071	2000	Green
12	$\pm 2, \pm 5, \pm 10\%$	250	38	3.00	0.075	2000	Blue
15	$\pm 2, \pm 5, \pm 10\%$	250	38	2.80	0.080	1900	Violet
18	$\pm 2, \pm 5, \pm 10\%$	250	40	2.80	0.099	1900	Gray
22	$\pm 2, \pm 5, \pm 10\%$	250	42	2.40	0.099	1800	White
24	$\pm 2, \pm 5, \pm 10\%$	250	42	2.40	0.105	1800	Black

### HIGH Q ELECTRICAL SPECIFICATIONS

#### 0805

Inductance (nH)	Tolerance	L Freq. (MHz)	Quality Factor min.	SRF (GHz) min.	DCR ( $\Omega$ ) max.	IDC (mA) max.	Color Code
2.5	$\pm 5, \pm 10\%$	250	80 @ 1500MHz	6.00	0.020	1600	Black
5.6	$\pm 5, \pm 10\%$	250	98 @ 1500MHz	6.00	0.035	1600	Brown
6.2	$\pm 5, \pm 10\%$	250	88 @ 1000MHz	4.75	0.035	1600	Red
6.8	$\pm 5, \pm 10\%$	250	80 @ 1000MHz	4.40	0.035	1600	White
8.2	$\pm 5, \pm 10\%$	250	75 @ 1000MHz	3.00	0.075	1000	Gray
10	$\pm 5, \pm 10\%$	250	80 @ 1000MHz	3.00	0.060	1600	Black
12	$\pm 5, \pm 10\%$	250	80 @ 1000MHz	3.00	0.045	1600	Orange
15	$\pm 2, \pm 5, \pm 10\%$	250	80 @ 1000MHz	2.80	0.100	1200	Black
16	$\pm 2, \pm 5, \pm 10\%$	250	72 @ 500MHz	2.95	0.060	1500	Yellow
18	$\pm 2, \pm 5, \pm 10\%$	250	75 @ 500MHz	2.55	0.060	1400	Green
20	$\pm 2, \pm 5, \pm 10\%$	250	70 @ 500MHz	2.05	0.055	1400	Blue
22	$\pm 2, \pm 5, \pm 10\%$	250	80 @ 500MHz	2.00	0.100	1200	Black
27	$\pm 2, \pm 5, \pm 10\%$	250	75 @ 500MHz	2.00	0.070	1300	Violet
30	$\pm 2, \pm 5, \pm 10\%$	250	65 @ 500MHz	1.95	0.095	1200	Gray
39	$\pm 2, \pm 5, \pm 10\%$	250	65 @ 500MHz	1.60	0.110	1100	White
48	$\pm 2, \pm 5, \pm 10\%$	200	65 @ 500MHz	1.40	0.095	1200	Black
51	$\pm 2, \pm 5, \pm 10\%$	200	65 @ 500MHz	1.40	0.120	1000	Brown

#### 1008

Inductance (nH)	Tolerance	L Freq. (MHz)	Quality Factor min.	SRF (GHz) min.	DCR ( $\Omega$ ) max.	IDC (mA) max.	Color Code
3.0	$\pm 5, \pm 10\%$	50	70 @ 1500MHz	6.00	0.04	1600	Black
3.9	$\pm 5, \pm 10\%$	50	75 @ 1500MHz	6.00	0.05	1600	White
4.1	$\pm 5, \pm 10\%$	50	75 @ 1500MHz	6.00	0.05	1600	Brown
7.8	$\pm 5, \pm 10\%$	50	75 @ 500MHz	3.80	0.05	1600	Red
10	$\pm 2, \pm 5, \pm 10\%$	50	60 @ 500MHz	3.60	0.06	1600	Orange
12	$\pm 2, \pm 5, \pm 10\%$	50	70 @ 500MHz	2.80	0.06	1500	Yellow
18	$\pm 2, \pm 5, \pm 10\%$	50	62 @ 350MHz	2.70	0.07	1400	Green
22	$\pm 2, \pm 5, \pm 10\%$	50	62 @ 350MHz	2.05	0.07	1400	Blue
33	$\pm 2, \pm 5, \pm 10\%$	50	75 @ 350MHz	1.70	0.09	1300	Violet
39	$\pm 2, \pm 5, \pm 10\%$	50	75 @ 350MHz	1.30	0.09	1300	Gray
47	$\pm 2, \pm 5, \pm 10\%$	50	75 @ 350MHz	1.45	0.12	1200	White
56	$\pm 2, \pm 5, \pm 10\%$	50	75 @ 350MHz	1.23	0.12	1200	Black
68	$\pm 2, \pm 5, \pm 10\%$	50	80 @ 350MHz	1.15	0.13	1100	Brown
82	$\pm 2, \pm 5, \pm 10\%$	50	80 @ 350MHz	1.06	0.16	1100	Red
100	$\pm 2, \pm 5, \pm 10\%$	50	50 @ 350MHz	0.82	0.16	1000	Orange

# Wire Wound Chip Inductor



## LCWC Series

### ENVIRONMENTAL CHARACTERISTICS

#### MECHANICAL PERFORMANCE TEST

Items	Requirement	Test Methods
Inductance	Refer to standard electrical characteristic spec.	HP4286
Q		HP4286
SRF		HP4287
DC Resistance RDC		Micro-Ohm meter (Gom-801G)
Rated Current IDC		Applied the current to coils, The inductance change should be less than 10% to initial value
Over Load	Inductors shall have no evidence of electrical and mechanical damage	Applied 2 times of rated allowed DC current to inductor for a period of 5 minutes
Withstanding Voltage	Inductors shall be no evidence of electrical and mechanical damage.	AC voltage of 500 VAC applied between inductors terminal and case for 1 min.
Insulation Resistance	1000M ohm min.	100 VDC applied between inductor terminal and case and case

#### MECHANICAL PERFORMANCE TEST

Items	Requirement	Test Methods
Vibration	Appearance: No damage L change: within $\pm 5\%$ Q change: within $\pm 10\%$	Test device shall be soldered on the substrate Oscillation Frequency: 10 to 55 to 10Hz for 1 min. Amplitude: 1.5 mm Time: 2 hrs for each axis (X, Y & Z), total 6 hrs
Resistance to Soldering Heat		Solder Temperature: $260 \pm 50^\circ\text{C}$ Immersion Time: $10 \pm 2$ seconds
Component Adhesion (Push Test)	1 lbs. For 0402 2 lbs. For 0603 3 lbs. For the rest	The device should be soldered ( $260 \pm 5$ for 10 seconds) to a tinned copper subs rate. A dynamiter force gauge should be applied to the side of the component. The device must with stand a minimum force of 2 or 4 pounds without a failure of adhesion on termination
Drop	No damage	Dropping chip by each side and each corner. Drop 10 times in total Drop height: 100 cm Drop weight: 125 g
Solderability	90% covered with solder	Inductor shall be dipped in a melted solder bath at $245 \pm 5$ for 3 seconds
Resistance to Solvent	No damage on appearance and marking	MIL-STD202F, Method 215D

#### CLIMATIC TEST

Items	Requirement	Test Methods															
Temperature Characteristic	Appearance: No damage L change: within $\pm 10\%$ Q change: within $\pm 20\%$	$-40 \sim +125^\circ\text{C}$															
Humidity		Temperature: $40 \pm 2^\circ\text{C}$ Relative Humidity: 90 ~ 95% Time: $96 \pm 2$ hrs Measured after exposure in the room condition for 2 hrs															
Low Temperature Storage		Temperature: $-40 \pm 2^\circ\text{C}$ Time: $96 \pm 2$ hrs Inductors are tested after 1 hour at room temperature															
Thermal Shock		One cycle: <table border="1" style="margin-left: 20px;"> <thead> <tr> <th>Step</th> <th>Temperature (<math>^\circ\text{C}</math>)</th> <th>Time (min.)</th> </tr> </thead> <tbody> <tr> <td>1</td> <td><math>-25 \pm 3</math></td> <td>30</td> </tr> <tr> <td>2</td> <td><math>25 \pm 2</math></td> <td>15</td> </tr> <tr> <td>3</td> <td><math>125 \pm 3</math></td> <td>30</td> </tr> <tr> <td>4</td> <td><math>25 \pm 2</math></td> <td>15</td> </tr> </tbody> </table>	Step	Temperature ( $^\circ\text{C}$ )	Time (min.)	1	$-25 \pm 3$	30	2	$25 \pm 2$	15	3	$125 \pm 3$	30	4	$25 \pm 2$	15
Step		Temperature ( $^\circ\text{C}$ )	Time (min.)														
1		$-25 \pm 3$	30														
2		$25 \pm 2$	15														
3	$125 \pm 3$	30															
4	$25 \pm 2$	15															
High Temperature Storage	Temperature: $125 \pm 2^\circ\text{C}$ Time: $96 \pm 2$ hrs Measured after exposure in the room condition for 1 hour																
High Temperature Load Life	Temperature: $85 \pm 2^\circ\text{C}$ Time: $1000 \pm 12$ hrs Load: Allowed DC current																
Damp Heat with Load	Temperature: $40 \pm 2^\circ\text{C}$ Relative Humidity: 90 ~ 95% Time: $1000 \pm 12$ hrs Load: Allowed DC current																



# Wire Wound Chip Inductor



## LCWC Series

### REEL DIMENSIONS AND PACKAGING QUANTITY

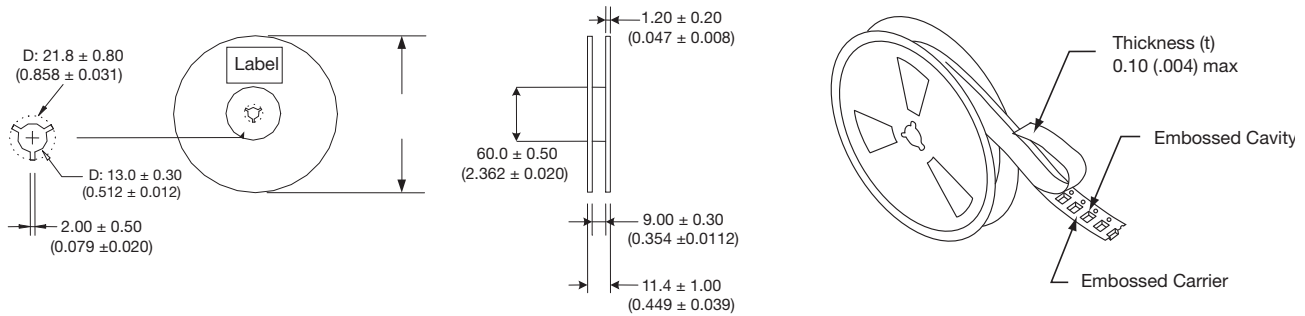

### PAPER TAPE SPECIFICATION AND PACKAGING QUANTITY

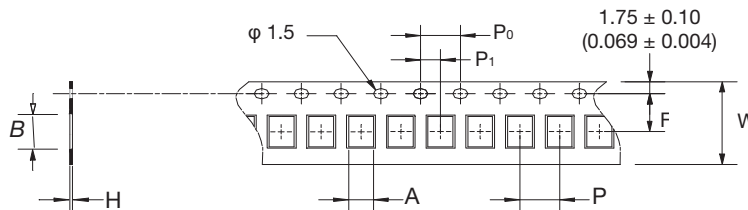

mm (inches)

Type	A	B	H	F	P	P <sub>0</sub>	P <sub>1</sub>	W	Reel (EA)
LCWC0402	0.72 (0.028)	1.19 (0.047)	0.60 (0.024)	3.50 (0.138)	4.00 (0.157)	4.00 (0.147)	2.00 (0.079)	8.00 (0.315)	4,000
LCWC0603	1.35 (0.053)	1.95 (0.077)	0.95 (0.037)	3.50 (0.138)	4.00 (0.157)	4.00 (0.147)	2.00 (0.079)	8.00 (0.315)	4,000

### EMBOSSED PLASTIC PAPER TAPE SPECIFICATION AND PACKAGING QUANTITY

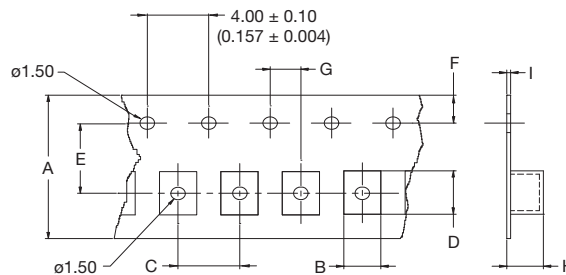

mm (inches)

Type	A	B	C	D	E	F	G	H	I	Reel (EA)
LCWC0805	8.00 ± 0.20 (0.315 ± 0.008)	1.85 ± 0.10 (0.073 ± 0.073)	4.00 ± 0.10 (0.157 ± 0.073)	2.30 ± 0.10 (0.091 ± 0.073)	3.50 ± 0.05 (0.138 ± 0.002)	1.75 ± 0.10 (0.069 ± 0.073)	2.00 ± 0.05 (0.079 ± 0.002)	1.45 ± 0.05 (0.057 ± 0.002)	0.23 ± 0.05 (0.009 ± 0.002)	2,000
LCWC0805 (R)	8.00 ± 0.20 (0.315 ± 0.008)	1.80 ± 0.10 (0.071 ± 0.073)	4.00 ± 0.10 (0.157 ± 0.073)	2.30 ± 0.10 (0.091 ± 0.073)	3.50 ± 0.05 (0.138 ± 0.002)	1.75 ± 0.10 (0.069 ± 0.073)	2.00 ± 0.05 (0.079 ± 0.002)	0.90 ± 0.05 (0.035 ± 0.002)	0.23 ± 0.05 (0.009 ± 0.002)	2,000
LCWC0805 (Q)	8.00 ± 0.20 (0.315 ± 0.008)	1.85 ± 0.10 (0.073 ± 0.073)	4.00 ± 0.10 (0.157 ± 0.073)	2.30 ± 0.10 (0.091 ± 0.073)	3.50 ± 0.05 (0.138 ± 0.002)	1.75 ± 0.10 (0.069 ± 0.073)	2.00 ± 0.05 (0.079 ± 0.002)	1.45 ± 0.05 (0.057 ± 0.002)	0.23 ± 0.05 (0.009 ± 0.002)	2,000
LCWC1206	8.00 ± 0.20 (0.315 ± 0.008)	1.95 ± 0.10 (0.077 ± 0.073)	4.00 ± 0.10 (0.157 ± 0.073)	3.50 ± 0.10 (0.138 ± 0.073)	3.50 ± 0.05 (0.138 ± 0.002)	1.75 ± 0.10 (0.069 ± 0.073)	2.00 ± 0.05 (0.079 ± 0.002)	1.50 ± 0.05 (0.059 ± 0.002)	0.23 ± 0.05 (0.009 ± 0.002)	2,000
LCWC1008	8.00 ± 0.20 (0.315 ± 0.008)	2.70 ± 0.10 (0.106 ± 0.073)	4.00 ± 0.10 (0.157 ± 0.073)	2.80 ± 0.10 (0.110 ± 0.073)	3.50 ± 0.05 (0.138 ± 0.002)	1.75 ± 0.10 (0.069 ± 0.073)	2.00 ± 0.05 (0.079 ± 0.002)	2.00 ± 0.05 (0.079 ± 0.002)	0.23 ± 0.05 (0.009 ± 0.002)	2,000
LCWC1008 (R)	8.00 ± 0.20 (0.315 ± 0.008)	2.70 ± 0.10 (0.106 ± 0.073)	4.00 ± 0.10 (0.157 ± 0.073)	2.80 ± 0.10 (0.110 ± 0.073)	3.50 ± 0.05 (0.138 ± 0.002)	1.75 ± 0.10 (0.069 ± 0.073)	2.00 ± 0.05 (0.079 ± 0.002)	1.50 ± 0.05 (0.059 ± 0.002)	0.23 ± 0.05 (0.009 ± 0.002)	2,000
LCWC1008 (Q)	8.00 ± 0.20 (0.315 ± 0.008)	2.70 ± 0.10 (0.106 ± 0.073)	4.00 ± 0.10 (0.157 ± 0.073)	2.80 ± 0.10 (0.110 ± 0.073)	3.50 ± 0.05 (0.138 ± 0.002)	1.75 ± 0.10 (0.069 ± 0.073)	2.00 ± 0.05 (0.079 ± 0.002)	2.00 ± 0.05 (0.079 ± 0.002)	0.23 ± 0.05 (0.009 ± 0.002)	2,000



# Wire Wound Chip Inductor (Ferrite)



## LCWF Series

### FEATURES

- Very strong solderability by reflow soldering, soldering iron or wave soldering
- Highly accurate dimensions
- Automated mounting capable
- Terminals are highly resistant to pull forces
- Highly resistant to mechanical shocks and pressure
- Highly reliable in sudden temperature and humidity changes
- Superb Q characteristics

### APPLICATIONS

- DC/DC Converters
- LCD Televisions
- Personal Computers
- Tablets
- Cell Phones
- Automotive Sound Systems
- Mobile Communications Devices

### CONSTRUCTION

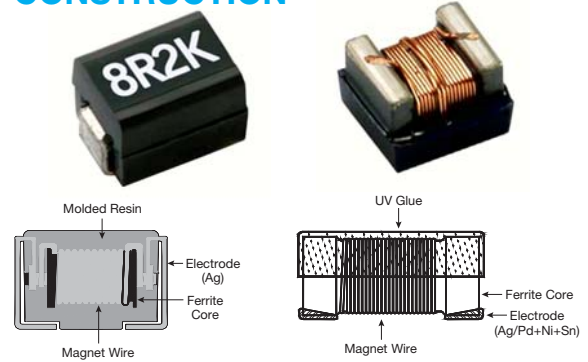

These revolutionary, high reliability wound chip inductors have been developed in response to the trend toward higher densities in electronic equipment.

With metal terminals and a body of heat resistant resin, these inductors offer many superior features.

### DIMENSIONS

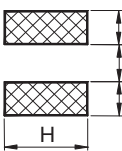
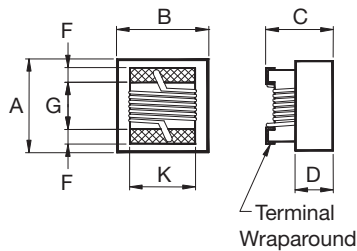

Figure 1

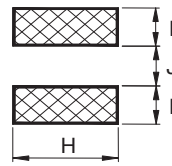
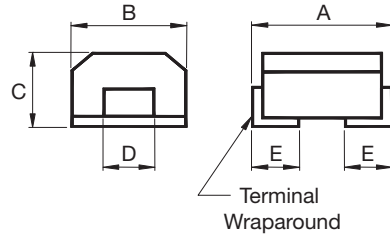

Figure 2

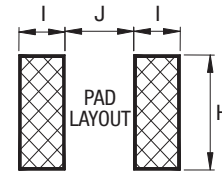
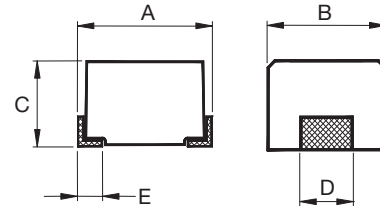

Figure 3

mm (inches)

Style	Size (inch)	Figure	A Max.	B Max.	C Max.	D Ref.	E	F	G	H	I	J	K	Weight (g) (1000pcs)
G	0603	1	1.80 (0.071)	1.20 (0.047)	1.00 (0.039)	0.45 (0.018)	-	0.33 (0.013)	0.95 (0.037)	1.02 (0.040)	1.64 (0.065)	0.64 (0.025)	1.05 (0.042)	9.6
G	0805	1	2.40 (0.094)	1.71 (0.067)	1.45 (0.057)	0.65 (0.026)	-	0.44 (0.017)	1.02 (0.040)	1.78 (0.070)	1.02 (0.040)	0.76 (0.030)	1.27 (0.050)	14
G	1008	1	2.92 (0.115)	2.79 (0.110)	2.10 (0.083)	1.20 (0.047)	-	0.45 (0.018)	1.52 (0.060)	2.54 (0.100)	1.02 (0.040)	1.27 (0.050)	2.03 (0.080)	30
G	1210	2	3.50 (0.138)	2.80 (0.110)	2.50 (0.098)	1.60 (0.063)	0.80 (0.031)	-	-	2.00 (0.079)	1.20 (0.047)	1.60 (0.063)	-	40
G	1812	2	4.80 (0.189)	3.50 (0.138)	3.50 (0.138)	1.80 (0.071)	1.10 (0.043)	-	-	2.80 (0.110)	1.50 (0.059)	3.00 (0.118)	-	160
G	2220	3	5.90 (0.232)	5.20 (0.205)	4.30 (0.169)	4.00±0.2 (0.157±0.008)	0.70±0.20 (0.028±0.008)	-	-	4.50 (0.177)	2.00 (0.079)	4.00 (0.157)	-	300
R	0805	1	2.29 (0.090)	1.73 (0.068)	1.00 (0.039)	0.51 (0.020)	-	0.44 (0.017)	1.02 (0.040)	1.78 (0.070)	1.02 (0.040)	0.76 (0.030)	1.27 (0.050)	14
H	0603	1	1.80 (0.071)	1.20 (0.047)	1.10 (0.043)	0.45 (0.018)	-	0.33 (0.013)	0.95 (0.037)	1.02 (0.040)	1.64 (0.065)	0.64 (0.025)	1.05 (0.041)	9.6
H	0805	1	2.40 (0.094)	1.71 (0.067)	1.45 (0.057)	0.65 (0.026)	-	0.44 (0.017)	1.02 (0.040)	1.78 (0.070)	1.02 (0.040)	0.76 (0.030)	1.27 (0.050)	14
H	1008	1	2.92 (0.115)	2.79 (0.110)	2.10 (0.083)	1.30 (0.051)	-	0.45 (0.018)	1.52 (0.060)	2.54 (0.100)	1.02 (0.040)	1.27 (0.050)	2.03 (0.080)	30
H	1812	2	4.80 (0.189)	3.50 (0.138)	3.50 (0.138)	1.40 (0.055)	1.10 (0.043)	-	-	2.80 (0.110)	1.50 (0.059)	3.00 (0.118)	-	160
H	2220	3	5.90 (0.232)	5.20 (0.205)	4.30 (0.169)	4.00±0.20 (0.157±0.008)	0.70±0.20 (0.028±0.008)	-	-	4.50 (0.177)	2.00 (0.079)	4.00 (0.157)	-	300



# Wire Wound Chip Inductor (Ferrite)



## LCWF Series

### COLOR CODING

0603 / 0805 / 1008 Type

Because of small sizes, these parts are marked with a single color dot.

The inductance value represented by the dot is shown on the data page for each type.

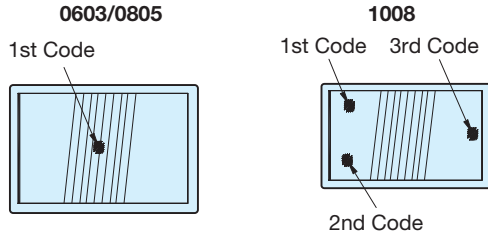

### HOW TO ORDER

<b>LC</b>	<b>WF</b>	<b>0603</b>	<b>M</b>	<b>101</b>	<b>G</b>	<b>T</b>	<b>A</b>	<b>R</b>
<b>Family</b> LC = Chip Inductor	<b>Series</b> WF = Wire Wound Ferrite	<b>Size</b> 0603 0805 1008 1210 1812 2220	<b>Tolerance</b> J = 5% K = 10% M = 20%	<b>Inductance</b> 39N = 0.039µH R39 = 0.390µH 3R9 = 3.90µH 390 = 39µH 391 = 390µH 392 = 3900µH 103 = 10,000µH	<b>Style</b> G = Standard H = High Current/ High Q R = Low Profile	<b>Termination</b> T = Sn Plating	<b>Special</b> A = Standard	<b>Packaging</b> R = 7" Reel

### STANDARD ELECTRICAL SPECIFICATIONS

0603								
Codes	Inductance (µH)	Tolerance	Test Freq. (MHz)	Q Typ.	SRF (MHz) Typ.	DCR (Ω) Max.	IDC (mA) Max.	Color Code
1R0	1.0	±10, ±20%	7.96	16	390	0.416	860	Black
1R5	1.5	±10, ±20%	7.96	16	160	0.520	720	Brown
1R8	1.8	±10, ±20%	7.96	16	121	0.559	640	Red
2R2	2.2	±10, ±20%	7.96	16	103	0.728	600	Orange
2R7	2.7	±10, ±20%	7.96	16	72	0.806	540	Yellow
3R3	3.3	±10, ±20%	7.96	16	66	0.910	500	Green
3R9	3.9	±10, ±20%	7.96	16	61	1.079	460	Blue
4R7	4.7	±10, ±20%	7.96	16	51	1.261	400	Violet
5R6	5.6	±10, ±20%	7.96	16	47	1.430	380	Gray
6R8	6.8	±10, ±20%	7.96	16	43	1.950	340	White
8R2	8.2	±10, ±20%	7.96	16	40	2.184	300	Black
100	10	±10, ±20%	2.52	14	36	2.405	280	Brown
120	12	±10, ±20%	2.52	14	32	2.964	260	Red
150	15	±10, ±20%	2.52	14	29	3.380	240	Orange
180	18	±10, ±20%	2.52	14	28	3.770	220	Yellow
220	22	±10, ±20%	2.52	14	24	4.693	200	Green
270	27	±10, ±20%	2.52	14	20	6.760	140	Blue
330	33	±10, ±20%	2.52	14	15	8.580	120	Violet

Test Equipment: L, Q: HP4291 SRF: HP4291 RDC: Agilent 34401A



# Wire Wound Chip Inductor (Ferrite)



## LCWF Series

### 0805

Codes	Inductance (µH)	Tolerance	Test Freq. (MHz)	Q Typ.	SRF (MHz) Typ.	DCR (Ω) Max.	IDC (mA) Max.	Color Code
R11	0.11	±10%	25.2	25	1200	0.05	2000	White
R12	0.12	±5, ±10%	25.2	20	700	0.18	1100	Violet
R15	0.15	±5, ±10%	25.2	20	900	0.18	1100	Gray
R18	0.18	±5, ±10%	25.2	20	600	0.20	800	Black
R22	0.22	±5, ±10%	25.2	20	550	0.25	700	Brown
R27	0.27	±5, ±10%	25.2	20	550	0.38	700	Red
R33	0.33	±5, ±10%	25.2	20	550	0.35	650	Orange
R39	0.39	±5, ±10%	25.2	20	420	0.35	600	Yellow
R47	0.47	±5, ±10%	25.2	20	350	0.45	600	Green
R56	0.56	±5, ±10%	25.2	20	300	0.45	550	Blue
R62	0.62	±5, ±10%	25.2	30	640	0.45	980	Brown
R68	0.68	±5, ±10%	25.2	20	300	0.60	500	Violet
R82	0.82	±5, ±10%	25.2	20	300	0.55	500	Gray
R91	0.91	±5, ±10%	25.2	30	500	0.55	900	Yellow
1R0	1.0	±5, ±10%	7.96	15	280	0.80	450	White
1R2	1.2	±5, ±10%	7.96	15	280	0.90	400	Black
1R5	1.5	±5, ±10%	7.96	15	250	1.05	350	Brown
1R8	1.8	±5, ±10%	7.96	15	120	1.00	350	Red
2R2	2.2	±5, ±10%	7.96	15	110	1.10	320	Orange
2R7	2.7	±5, ±10%	7.96	15	70	1.20	320	Yellow
3R3	3.3	±5, ±10%	7.96	15	60	1.50	300	Green
3R9	3.9	±5, ±10%	7.96	15	55	1.75	300	Blue
4R7	4.7	±5, ±10%	7.96	15	45	2.10	200	Violet
5R6	5.6	±5, ±10%	7.96	15	40	2.30	250	Gray
6R8	6.8	±5, ±10%	7.96	15	36	2.70	200	White
8R2	8.2	±5, ±10%	7.96	15	33	3.30	180	Black
100	10	±5, ±10%	2.52	10	30	4.50	180	Brown
120	12	±5, ±10%	2.52	16	37	2.80	220	Red
150	15	±5, ±10%	2.52	16	30	3.80	200	Orange
180	18	±5, ±10%	2.52	16	23	4.48	180	Yellow
220	22	±5, ±10%	2.52	16	20	6.30	160	Green
270	27	±5, ±10%	2.52	16	19	6.85	140	Blue
330	33	±5, ±10%	2.52	16	18	7.60	120	Violet
390	39	±5, ±10%	2.52	15	16	8.20	100	Gray

Test Equipment: L, Q: HP4291 SRF: HP4291 RDC: Agilent 34401A

# Wire Wound Chip Inductor (Ferrite)



## LCWF Series

### 1008

Codes	Inductance (μH)	Tolerance	Test Freq. (MHz)	Q Typ.	SRF (MHz) Typ.	DCR (Ω) Max.	IDC (mA) Max.	Color Code		
R12	0.12	±5, ±10%	25.2	26	800	0.30	1000	Brown	Red	Brown
R18	0.18	±5, ±10%	25.2	30	600	0.30	960	Red	Gray	Brown
R20	0.20	±5, ±10%	25.2	30	735	0.30	960	Red	Black	Brown
R22	0.22	±5, ±10%	25.2	27	600	0.40	880	Red	Red	Brown
R27	0.27	±5, ±10%	25.2	29	425	0.42	900	Red	Violet	Brown
R33	0.33	±5, ±10%	25.2	30	400	0.42	900	Orange	Orange	Brown
R39	0.39	±5, ±10%	25.2	30	375	0.45	700	Orange	White	Brown
R47	0.47	±5, ±10%	25.2	30	350	0.50	900	Yellow	Violet	Brown
R56	0.56	±5, ±10%	25.2	30	325	0.55	850	Green	Blue	Brown
R62	0.62	±5, ±10%	25.2	30	460	0.55	900	Blue	Red	Brown
R68	0.68	±5, ±10%	25.2	30	300	0.55	800	Blue	Gray	Brown
R75	0.75	±5, ±10%	25.2	30	420	0.65	880	Violet	Green	Brown
R82	0.82	±5, ±10%	25.2	30	260	0.65	700	Gray	Red	Brown
R91	0.91	±5, ±10%	25.2	30	400	0.65	840	White	Brown	Brown
1R0	1.0	±5, ±10%	7.96	25	245	0.60	600	Brown	Black	Red
1R2	1.2	±5, ±10%	7.96	25	230	0.74	600	Brown	Red	Red
1R5	1.5	±5, ±10%	7.96	25	182	0.85	550	Brown	Green	Red
1R8	1.8	±5, ±10%	7.96	25	135	0.92	500	Brown	Gray	Red
2R2	2.2	±5, ±10%	7.96	25	105	1.10	500	Red	Red	Red
2R7	2.7	±5, ±10%	7.96	25	70	1.22	350	Red	Violet	Red
3R3	3.3	±5, ±10%	7.96	25	55	1.37	350	Orange	Orange	Red
3R9	3.9	±5, ±10%	7.96	25	48	1.66	310	Orange	White	Red
4R7	4.7	±5, ±10%	7.96	25	43	1.68	300	Yellow	Violet	Red
5R6	5.6	±5, ±10%	7.96	25	42	1.75	300	Green	Blue	Red
6R8	6.8	±5, ±10%	7.96	25	39	1.85	300	Blue	Gray	Red
8R2	8.2	±5, ±10%	7.96	25	36	2.00	250	Gray	Red	Red
100	10	±5, ±10%	2.52	20	33	2.32	250	Brown	Black	Orange
120	12	±5, ±10%	2.52	15	28	2.99	200	Brown	Red	Orange
150	15	±5, ±10%	2.52	15	24	3.42	200	Brown	Green	Orange
180	18	±5, ±10%	2.52	15	20	4.65	180	Brown	Gray	Orange
220	22	±5, ±10%	2.52	15	18	5.12	180	Red	Red	Orange
270	27	±5, ±10%	2.52	15	17	5.76	160	Red	Violet	Orange
330	33	±5, ±10%	2.52	15	16	6.44	120	Orange	Orange	Orange
390	39	±5, ±10%	2.52	15	15	6.85	120	Orange	White	Orange
470	47	±5, ±10%	2.52	14	13	9.94	110	Yellow	Violet	Orange
560	56	±5, ±10%	2.52	14	10	10.7	90	Green	Blue	Orange
680	68	±5, ±10%	2.52	14	8	12.8	90	Blue	Gray	Orange
820	82	±5, ±10%	2.52	14	8	18.3	80	Gray	Red	Orange
101	100	±5, ±10%	1	8	7	19.6	120	Brown	Black	Orange

Test Equipment: L, Q: HP4291 SRF: HP4291 RDC: Agilent 34401A



# Wire Wound Chip Inductor (Ferrite)



## LCWF Series

### 1210

Codes	Inductance (μH)	Tolerance	Test Freq. (MHz)	Q. Min.	SRF (MHz) min.	DCR (Ω) max.	IDC (mA) max.
R18	0.18	±20%	25.2	30	400	0.28	450
R22	0.22	±20%	25.2	30	350	0.32	450
R27	0.27	±20%	25.2	30	320	0.36	450
R33	0.33	±20%	25.2	30	300	0.40	450
R39	0.39	±20%	25.2	30	250	0.45	450
R47	0.47	±20%	25.2	30	220	0.50	450
R56	0.56	±20%	25.2	30	180	0.55	450
R68	0.68	±20%	25.2	30	160	0.60	450
R82	0.82	±20%	25.2	30	140	0.65	450
1R0	1.0	±10%	7.96	30	120	0.70	400
1R2	1.2	±10%	7.96	30	100	0.75	390
1R5	1.5	±10%	7.96	30	85	0.85	370
1R8	1.8	±10%	7.96	30	80	0.90	350
2R2	2.2	±10%	7.96	30	75	1.00	320
2R7	2.7	±10%	7.96	30	70	1.10	290
3R3	3.3	±10%	7.96	30	60	1.20	260
3R9	3.9	±10%	7.96	30	55	1.30	250
4R7	4.7	±10%	7.96	30	50	1.50	220
5R6	5.6	±10%	7.96	30	45	1.60	200
6R8	6.8	±10%	7.96	30	40	1.80	180
8R2	8.2	±10%	7.96	30	35	2.00	170
100	10	±10%	2.52	30	30	2.10	150
120	12	±10%	2.52	30	20	2.50	140
150	15	±10%	2.52	30	20	2.80	130
180	18	±10%	2.52	30	20	3.30	120
220	22	±10%	2.52	30	20	3.70	110
270	27	±10%	2.52	30	20	5.00	80
330	33	±10%	2.52	30	17	5.60	70
390	39	±10%	2.52	30	16	6.40	65
470	47	±10%	2.52	30	15	7.00	60
560	56	±10%	2.52	30	13	8.00	55
680	68	±10%	2.52	30	12	9.00	50
820	82	±10%	2.52	30	11	10.00	45
101	100	±10%	0.796	20	10	10.00	40
121	120	±10%	0.796	20	10	11.00	70
151	150	±10%	0.796	20	8	15.00	65
181	180	±10%	0.796	20	7	17.00	60
221	220	±10%	0.796	20	7	21.00	50

Test Equipment: L, Q: HP4291 for 0.18μH~82μH; HP4284 for 100μH~220μH SRF: HP4291 RDC: Agilent

# Wire Wound Chip Inductor (Ferrite)



## LCWF Series

### 1812

Codes	Inductance (µH)	Tolerance	Test Freq. (MHz)	Q. Min.	SRF (MHz) min.	DCR (Ω) max.	IDC (mA) max.
R18	0.18	±20%	25.2	30	220	0.24	700
R22	0.22	±20%	25.2	30	200	0.25	665
R27	0.27	±20%	25.2	30	180	0.26	635
R33	0.33	±20%	25.2	30	165	0.28	605
R39	0.39	±20%	25.2	30	150	0.30	575
R47	0.47	±20%	25.2	30	145	0.32	545
R56	0.56	±20%	25.2	30	140	0.36	520
R68	0.68	±20%	25.2	30	135	0.40	500
R82	0.82	±20%	25.2	30	130	0.45	475
1R0	1.0	±10%	7.96	50	100	0.50	450
1R2	1.2	±10%	7.96	50	80	0.55	430
1R5	1.5	±10%	7.96	50	70	0.60	410
1R8	1.8	±10%	7.96	50	60	0.65	390
2R2	2.2	±10%	7.96	50	55	0.70	380
2R7	2.7	±10%	7.96	50	50	0.75	370
3R3	3.3	±10%	7.96	50	45	0.80	355
3R9	3.9	±10%	7.96	50	40	0.90	330
4R7	4.7	±10%	7.96	50	35	1.00	315
5R6	5.6	±10%	7.96	50	33	1.10	300
6R8	6.8	±10%	7.96	50	27	1.20	285
8R2	8.2	±10%	7.96	50	25	1.40	270
100	10	±10%	2.52	50	20	1.60	250
120	12	±10%	2.52	50	18	2.00	225
150	15	±10%	2.52	50	17	2.50	200
180	18	±10%	2.52	50	15	2.80	190
220	22	±10%	2.52	50	13	3.20	180
270	27	±10%	2.52	50	12	3.60	170
330	33	±10%	2.52	50	11	4.00	160
390	39	±10%	2.52	50	10	4.50	150
470	47	±10%	2.52	50	10	5.00	140
560	56	±10%	2.52	50	9	5.50	135
680	68	±10%	2.52	50	9	6.00	130
820	82	±10%	2.52	50	8	7.00	120
101	100	±10%	0.796	40	8	8.00	110
121	120	±10%	0.796	40	6	8.00	110
151	150	±10%	0.796	40	5	9.00	105
181	180	±10%	0.796	40	5	9.50	102
221	220	±10%	0.796	40	4	10.0	100
271	270	±10%	0.796	30	4	15.0	92
331	330	±10%	0.796	30	3.5	15.0	85
391	390	±10%	0.796	30	3	18.0	80
471	470	±10%	0.796	30	3	26.0	62
561	560	±10%	0.796	30	3	30.0	50
681	680	±10%	0.796	30	3	30.0	50
821	820	±10%	0.796	30	2.5	43.0	30

Test Equipment: L, Q: HP4291 for 0.18µH~82µH; HP4284 for 100µH~820µH SRF: HP4291 RDC: Agilent 34401A

### 2220

Codes	Inductance (µH)	Tolerance	Test Freq. (MHz)	Q. Min.	SRF (MHz) min.	DCR (Ω) max.	IDC (mA) max.
122	1200	±5, ±10%	0.252	20	1.5	17	75
152	1500	±5, ±10%	0.252	20	1.4	20	70
182	1800	±5, ±10%	0.252	20	1.3	30	60
222	2200	±5, ±10%	0.252	20	1.2	35	55
272	2700	±5, ±10%	0.252	20	1.1	55	45
332	3300	±5, ±10%	0.252	20	1.0	60	40
392	3900	±5, ±10%	0.252	20	1.0	70	38
472	4700	±5, ±10%	0.252	20	0.9	78	36
562	5600	±5, ±10%	0.252	20	0.8	85	33
682	6800	±5, ±10%	0.252	20	0.7	110	30
822	8200	±5, ±10%	0.252	20	0.6	125	28
103	10,000	±5, ±10%	0.0796	15	0.5	150	25

Test Equipment: L, Q: HP4284 SRF: HP4291 RDC: Agilent 34401A



# Wire Wound Chip Inductor (Ferrite)



## LCWF Series

### LOW PROFILE ELECTRICAL SPECIFICATIONS

#### 0805

Codes	Inductance (µH)	Tolerance	Q. Min.	Test Freq. (MHz)	SRF (MHz) min.	DCR (Ω) max.	IDC (mA) max.
1R0	1.0	±5, ±10%	15	7.96	115	0.90	450
3R3	3.3	±5, ±10%	13	7.96	70	1.40	450
4R7	4.7	±5, ±10%	15	7.96	65	1.90	400
6R8	6.8	±5, ±10%	15	7.96	41	2.40	400
100	10	±5, ±10%	14	7.96	31	2.70	400
150	15	±5, ±10%	12	7.96	28	5.00	300
220	22	±5, ±10%	10	7.96	25	6.00	250

Test Equipment: L, Q: HP4291 SRF: HP4291 RDC: Agilent 34401A

### LARGE CURRENT ELECTRICAL SPECIFICATIONS

#### 0603

Codes	Inductance (µH)	Tolerance	Q Typ.	Test Freq. (MHz)	SRF (MHz) Typ.	DCR (Ω) Max.	IDC (mA) Max.	Color Code
47N	0.047	±10%	12	7.96	2000	0.075	1800	White
51N	0.051	±10%	12	7.96	1500	0.075	1800	Violet
68N	0.068	±10%	12	7.96	1500	0.12	1800	Gray
72N	0.072	±10%	12	7.96	1500	0.12	1800	Brown
R10	0.10	±10%	12	7.96	1150	0.13	1700	Black
R12	0.12	±5, ±10%	12	7.96	1100	0.15	1700	Orange
R15	0.15	±5, ±10%	15	7.96	1050	0.15	1600	Brown
R18	0.18	±5, ±10%	15	7.96	950	0.15	1500	Green
R22	0.22	±5, ±10%	15	7.96	900	0.30	1200	Red
R24	0.24	±5, ±10%	15	7.96	850	0.16	1460	Green
R27	0.27	±5, ±10%	15	7.96	835	0.30	1460	Yellow
R33	0.33	±5, ±10%	15	7.96	725	0.40	1420	Orange
R39	0.39	±5, ±10%	15	7.96	680	0.41	1400	Blue
R47	0.47	±5, ±10%	15	7.96	640	0.43	1400	Black
R56	0.56	±5, ±10%	15	7.96	630	0.44	1400	Brown
R68	0.68	±5, ±10%	15	7.96	510	0.52	1340	Red
R78	0.78	±5, ±10%	15	7.96	465	0.63	1300	Orange
R82	0.82	±5, ±10%	15	7.96	460	0.69	1200	Yellow
1R0	1.0	±5, ±10%	15	7.96	320	0.81	1100	Green
1R2	1.2	±5, ±10%	15	7.96	270	0.87	1000	Blue
1R5	1.5	±5, ±10%	15	7.96	230	0.96	920	Violet
1R8	1.8	±5, ±10%	15	7.96	210	1.10	900	Gray
2R2	2.2	±5, ±10%	15	7.96	115	1.20	740	White
2R7	2.7	±5, ±10%	15	7.96	100	1.38	700	Black
3R3	3.3	±5, ±10%	15	7.96	84	1.50	680	Brown
3R9	3.9	±5, ±10%	15	7.96	75	1.50	600	Red
4R7	4.7	±5, ±10%	15	7.96	67	2.10	580	Orange
5R6	5.6	±5, ±10%	15	7.96	55	2.37	540	Yellow
6R8	6.8	±5, ±10%	15	7.96	48	3.10	500	Green
7R8	7.8	±5, ±10%	15	7.96	40	3.35	460	Blue
8R2	8.2	±5, ±10%	15	7.96	38	3.50	440	Violet
100	10	±5, ±10%	15	7.96	32	4.46	400	Gray

Test Equipment: L, Q: HP4291 SRF: HP4291 RDC: Agilent 34401A



# Wire Wound Chip Inductor (Ferrite)



## LCWF Series

### 0805

Codes	Inductance (μH)	Tolerance	Test Freq. (MHz)	Q Typ.	SRF (MHz) Typ.	DCR (Ω) Max.	IDC (mA) Max.	Color Code
R47	0.47	±10, ±20%	25.2	14	850	0.156	1400	Blue
R68	0.68	±10, ±20%	25.2	14	765	0.195	1200	Gray
1R0	1.00	±10, ±20%	7.96	14	208	0.169	1100	Black
1R2	1.20	±10, ±20%	7.96	14	159	0.208	960	Red
1R5	1.50	±10, ±20%	7.96	14	159	0.221	920	Brown
1R8	1.80	±10, ±20%	7.96	14	112	0.260	860	Orange
2R2	2.20	±10, ±20%	7.96	13	87	0.286	740	Red
2R7	2.70	±10, ±20%	7.96	13	72	0.325	680	Yellow
3R3	3.30	±10, ±20%	7.96	12	70	0.364	620	Orange
3R9	3.90	±10, ±20%	7.96	14	61	0.494	580	Green
4R7	4.70	±10, ±20%	7.96	14	51	0.559	520	Yellow
5R6	5.60	±10, ±20%	7.96	12	47	0.650	480	Blue
6R8	6.80	±10, ±20%	7.96	14	46	0.884	420	Green
8R2	8.20	±10, ±20%	7.96	13	33	0.949	400	Violet
100	10	±5, ±10, ±20%	2.52	14	31	1.105	360	Blue
120	12	±5, ±10, ±20%	2.52	14	30	1.17	340	Gray
150	15	±5, ±10, ±20%	2.52	15	28	1.82	300	Violet
180	18	±5, ±10, ±20%	2.52	15	27	2.01	280	White
220	22	±5, ±10, ±20%	2.52	15	20	2.28	240	Gray
270	27	±5, ±10, ±20%	2.52	15	17	2.60	220	Black
330	33	±5, ±10, ±20%	2.52	15	17	3.05	200	White
470	47	±5, ±10, ±20%	2.52	14	15	4.42	160	Black
560	56	±5, ±10, ±20%	2.52	14	10	5.74	150	Yellow
680	68	±5, ±10, ±20%	2.52	14	10	5.78	140	Brown
820	82	±5, ±10, ±20%	2.52	14	10	9.75	100	Orange
101	100	±5, ±10, ±20%	1	10	9	9.75	100	Red

Test Equipment: L, Q: HP4291 SRF: HP4291 RDC: Agilent 34401A

### 1008

Codes	Inductance (μH)	Tolerance	Q Typ.	Test Freq. (MHz)	SRF (MHz) Typ.	DCR (Ω) Max.	IDC (mA) Max.	Color Code		
R22	0.22	±5, ±10%	35	25.2	800	0.15	2600	Red	Red	Brown
R47	0.47	±5, ±10%	35	25.2	460	0.20	2400	Yellow	Violet	Brown
R68	0.68	±5, ±10%	35	25.2	400	0.30	2200	Blue	Gray	Brown
R82	0.82	±5, ±10%	35	25.2	360	0.35	1800	Gray	Red	Brown
1R0	1.0	±5, ±10%	22	7.96	245	0.35	800	Brown	Black	Red
1R2	1.2	±5, ±10%	25	7.96	230	0.40	550	Brown	Red	Red
1R5	1.5	±5, ±10%	25	7.96	182	0.45	550	Brown	Green	Red
1R8	1.8	±5, ±10%	25	7.96	135	0.55	550	Brown	Gray	Red
2R2	2.2	±5, ±10%	22	7.96	105	0.60	500	Red	Red	Red
2R7	2.7	±5, ±10%	25	7.96	70	0.70	500	Red	Violet	Red
3R3	3.3	±5, ±10%	22	7.96	55	0.75	450	Orange	Orange	Red
3R9	3.9	±5, ±10%	25	7.96	50	0.80	450	Orange	White	Red
4R7	4.7	±5, ±10%	22	7.96	45	0.90	400	Yellow	Violet	Red
5R6	5.6	±5, ±10%	22	7.96	42	1.05	400	Green	Blue	Red
6R8	6.8	±5, ±10%	22	7.96	40	1.05	400	Blue	Gray	Red
8R2	8.2	±5, ±10%	22	7.96	36	1.30	350	Gray	Red	Red
100	10	±5, ±10%	20	2.52	35	1.55	300	Brown	Black	Orange
120	12	±5, ±10%	20	2.52	30	2.10	280	Brown	Red	Orange
150	15	±5, ±10%	20	2.52	24	2.38	250	Brown	Green	Orange
180	18	±5, ±10%	20	2.52	20	2.60	200	Brown	Gray	Orange
220	22	±5, ±10%	20	2.52	18	2.92	200	Red	Red	Orange
330	33	±5, ±10%	20	2.52	16	4.10	180	Orange	Orange	Orange
470	47	±5, ±10%	23	2.52	17	7.80	350	Yellow	Violet	Orange
101	100	±5, ±10%	13	1	4	13.2	200	Brown	Black	Yellow
221	220	±5, ±10%	13	1	3	26.5	140	Red	Red	Yellow
331	330	±5, ±10%	13	1	2	32.5	110	Orange	Orange	Yellow

Test Equipment: L, Q: HP4291 SRF: HP4291 RDC: Agilent 34401A



# Wire Wound Chip Inductor (Ferrite)



## LCWF Series

### 1812

Codes	Inductance (µH)	Tolerance	Q. Min.	Test Freq. (MHz)	SRF (MHz) min.	DCR (Ω) max.	IDC (mA) max.
1R0	1.0	±10%	10	7.96	200	0.11	1050
1R2	1.2	±10%	10	7.96	160	0.12	1000
1R5	1.5	±10%	10	7.96	130	0.15	950
1R8	1.8	±10%	10	7.96	100	0.16	900
2R2	2.2	±10%	10	7.96	80	0.18	850
2R7	2.7	±10%	10	7.96	60	0.20	800
3R3	3.3	±10%	10	7.96	45	0.22	750
3R9	3.9	±10%	10	7.96	40	0.24	700
4R7	4.7	±10%	10	7.96	35	0.27	650
5R6	5.6	±10%	10	7.96	30	0.30	650
6R8	6.8	±10%	10	7.96	28	0.35	600
8R2	8.2	±10%	10	7.96	25	0.40	600
100	10	±10%	10	2.52	22	0.50	550
120	12	±10%	10	2.52	21	0.60	500
150	15	±10%	10	2.52	20	0.70	450
180	18	±10%	10	2.52	19	0.80	400
220	22	±10%	10	2.52	18	0.90	370
270	27	±10%	10	2.52	16	1.20	330
330	33	±10%	10	2.52	14	1.40	300
390	39	±10%	10	2.52	12	1.60	280
470	47	±10%	10	2.52	11.5	1.90	260
560	56	±10%	10	2.52	11	2.20	240
680	68	±10%	10	2.52	10	2.60	220
820	82	±10%	10	2.52	9	3.50	200
101	100	±10%	20	0.796	8	4.00	180
121	120	±10%	20	0.796	7.5	4.50	160
151	150	±10%	20	0.796	7	6.50	140
181	180	±10%	20	0.796	6.5	7.50	120
221	220	±10%	20	0.796	5.5	9.00	120
271	270	±10%	20	0.796	5	11.0	100
331	330	±10%	20	0.796	4	13.0	90
391	390	±10%	20	0.796	3.8	23.0	80
471	470	±10%	20	0.796	3.5	26	75
561	560	±10%	20	0.796	2.8	30	70
681	680	±10%	20	0.796	2.6	40	65
821	820	±10%	20	0.796	2.5	45	60

Test Equipment: L, Q: HP4291 SRF: HP4291 RDC: Agilent 34401A

# Wire Wound Chip Inductor (Ferrite)



## LCWF Series

### 2220

Codes	Inductance (µH)	Tolerance	Q. Min.	Test Freq. (MHz)	SRF (MHz) min.	DCR (Ω) max.	IDC (mA) max.
1R0	1.0	±10, ±20%	10	7.96	95	0.03	1800
1R2	1.2	±10, ±20%	10	7.96	70	0.035	1700
1R5	1.5	±10, ±20%	10	7.96	55	0.04	1600
1R8	1.8	±10, ±20%	10	7.96	47	0.05	1400
2R2	2.2	±10, ±20%	10	7.96	42	0.06	1300
2R7	2.7	±10, ±20%	10	7.96	37	0.07	1200
3R3	3.3	±10, ±20%	10	7.96	34	0.08	1120
3R9	3.9	±10, ±20%	10	7.96	32	0.09	1050
4R7	4.7	±10, ±20%	10	7.96	29	0.11	950
5R6	5.6	±10, ±20%	10	7.96	26	0.13	880
6R8	6.8	±10, ±20%	10	7.96	24	0.15	810
8R2	8.2	±10, ±20%	10	7.96	22	0.18	750
100	10	±10, ±20%	10	2.52	19	0.21	690
120	12	±10, ±20%	10	2.52	17	0.25	630
150	15	±10, ±20%	10	2.52	16	0.30	580
180	18	±10, ±20%	10	2.52	14	0.36	530
220	22	±5, ±10%	10	2.52	13	0.43	480
270	27	±5, ±10%	10	2.52	11.5	0.52	440
330	33	±5, ±10%	10	2.52	10.5	0.62	400
390	39	±5, ±10%	10	2.52	9.5	0.72	370
470	47	±5, ±10%	10	2.52	8.5	0.85	340
560	56	±5, ±10%	10	2.52	7.8	1.00	310
680	68	±5, ±10%	10	2.52	7.0	1.2	290
820	82	±5, ±10%	10	2.52	6.4	1.4	270
101	100	±5, ±10%	20	0.796	6.0	1.6	250
121	120	±5, ±10%	20	0.796	5.4	1.9	230
151	150	±5, ±10%	20	0.796	4.8	2.2	210
181	180	±5, ±10%	20	0.796	4.4	2.8	190
221	220	±5, ±10%	20	0.796	3.9	3.4	170
271	270	±5, ±10%	20	0.796	3.6	4.2	155
331	330	±5, ±10%	20	0.796	3.2	4.9	140
391	390	±5, ±10%	20	0.796	2.9	5.8	130
471	470	±5, ±10%	20	0.796	2.6	7.0	120
561	560	±5, ±10%	20	0.796	2.4	8.5	110
681	680	±5, ±10%	20	0.796	2.2	10	100
821	820	±5, ±10%	20	0.796	2.0	13	90
102	1000	±5, ±10%	20	0.252	1.8	15	85

Test Equipment: L, Q: HP4291 for 1.0pH ~ 82pH; HP4284 for 100pH ~ 1000pH SRF: HP4291 RDC: Agilent 34401A

# Wire Wound Chip Inductor (Ferrite)



## LCWF Series

### ENVIRONMENTAL CHARACTERISTICS

#### ELECTRICAL PERFORMANCE TEST

Items	Requirement	Test Methods
Inductance	Refer to standard electrical characteristic spec.	HP4291 or HP4284
Q		HP4291 or HP4284
SRF		HP4291
DC Resistance RDC		Agilent 34401A
Rated Current IDC		Applied the current to coils, The inductance change should be less than 10% to initial value

#### MECHANICAL PERFORMANCE TEST

Items	Requirement	Test Methods
Solderability	The electrodes shall be at least 90% covered with new solder coating	Lead-free inductor: after fluxing(alpha 100 or equiv), inductor shall be dipped in a melted solder bath at 245.5 C, 5.0.5 seconds
Resistance to Soldering Heat	Appearance: No damage	Pre-heating: 150°C, 1min. Solder Temperature: 260±5°C Immersion Time: 10±1 seconds
Vibration	Appearance: No damage L change: within±10% Q change: within±30% DCR: within specification	Test device shall be soldered on the substrate Oscillation Frequency: 10 to 55 to 10Hz for 1 min. Amplitude: 1.5 mm Time: 2 hrs for each axis (X, Y&Z), total 6 hrs

#### CLIMATIC TEST

Items	Requirement	Test Methods															
Temperature Cycle	Appearance: No damage L change: within±10% Q change: within±30% DCR: within specification	One cycle: <table border="1" style="margin-left: 20px;"> <thead> <tr> <th>Step</th> <th>Temperature (°C)</th> <th>Time (min.)</th> </tr> </thead> <tbody> <tr> <td>1</td> <td>-25±3</td> <td>30</td> </tr> <tr> <td>2</td> <td>25±2</td> <td>15</td> </tr> <tr> <td>3</td> <td>125±3</td> <td>30</td> </tr> <tr> <td>4</td> <td>25±2</td> <td>15</td> </tr> </tbody> </table>	Step	Temperature (°C)	Time (min.)	1	-25±3	30	2	25±2	15	3	125±3	30	4	25±2	15
Step		Temperature (°C)	Time (min.)														
1		-25±3	30														
2		25±2	15														
3	125±3	30															
4	25±2	15															
Damp Heat with Load	Temperature: 40±2°C Relative Humidity: 90 ~ 95% Time: 1000 hrs Measured after exposure in the room condition for 24 hrs																
High Temperature Storage	Temperature: 85±3°C Relative Humidity: 20% Applied Current: Rated Current Time: 1000 hrs Measured after exposure in the room condition for 24 hrs																
Low Temperature Storage	Temperature: -25±3°C Relative Humidity: 0% Time: 1000 hrs Measured after exposure in the room condition for 24 hrs																

Storage Temperature: 25±3°; Humidity < 80% RH

Operating Temperature Range: -40~+85°C

# Wire Wound Chip Inductor (Ferrite)



## LCWF Series

### DIMENSIONS

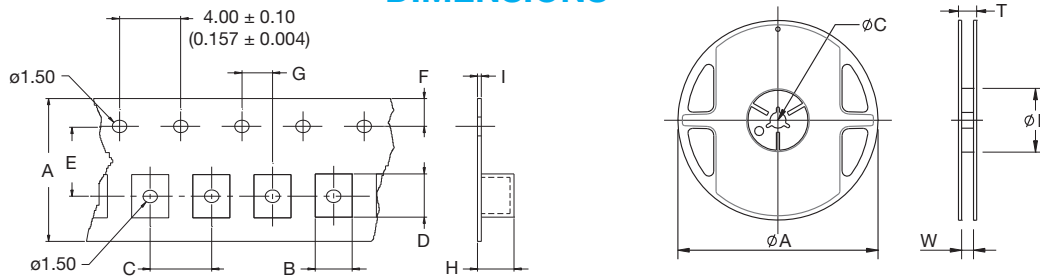

### TAPE DIMENSIONS

mm (inches)

Type	A	B	C	D	E	F	G	H	I	Qty/Reel
0603	8.00 ± 0.20 (0.315 ± 0.008)	1.25 ± 0.10 (0.049 ± 0.004)	4.00 ± 0.10 (0.157 ± 0.004)	1.90 ± 0.10 (0.075 ± 0.004)	3.50 ± 0.05 (0.138 ± 0.002)	1.75 ± 0.10 (0.069 ± 0.004)	2.00 ± 0.05 (0.079 ± 0.002)	1.00 ± 0.05 (0.039 ± 0.002)	0.23 ± 0.05 (0.009 ± 0.002)	4000
0805	8.00 ± 0.20 (0.315 ± 0.008)	1.85 ± 0.10 (0.073 ± 0.004)	4.00 ± 0.10 (0.157 ± 0.004)	2.55 ± 0.10 (0.100 ± 0.004)	3.50 ± 0.05 (0.138 ± 0.002)	1.75 ± 0.10 (0.069 ± 0.004)	2.00 ± 0.05 (0.079 ± 0.002)	1.45 ± 0.05 (0.057 ± 0.002)	0.23 ± 0.05 (0.009 ± 0.002)	2000
1008	8.00 ± 0.20 (0.315 ± 0.008)	2.80 ± 0.10 (0.110 ± 0.004)	4.00 ± 0.10 (0.157 ± 0.004)	2.95 ± 0.10 (0.116 ± 0.004)	3.50 ± 0.05 (0.138 ± 0.002)	1.75 ± 0.10 (0.069 ± 0.004)	2.00 ± 0.05 (0.079 ± 0.002)	2.22 ± 0.05 (0.087 ± 0.002)	0.23 ± 0.05 (0.009 ± 0.002)	2000
1210	8.00 ± 0.20 (0.315 ± 0.008)	2.96 ± 0.10 (0.117 ± 0.004)	4.00 ± 0.10 (0.157 ± 0.004)	3.60 ± 0.10 (0.142 ± 0.004)	3.50 ± 0.05 (0.138 ± 0.002)	1.75 ± 0.10 (0.069 ± 0.004)	2.00 ± 0.05 (0.079 ± 0.002)	2.40 ± 0.05 (0.094 ± 0.002)	0.23 ± 0.05 (0.009 ± 0.002)	2000
1812	12.0 ± 0.20 (0.472 ± 0.008)	3.30 ± 0.10 (0.130 ± 0.004)	8.00 ± 0.10 (0.315 ± 0.004)	5.00 ± 0.10 (0.197 ± 0.004)	5.50 ± 0.05 (0.217 ± 0.002)	1.75 ± 0.10 (0.069 ± 0.004)	2.00 ± 0.05 (0.079 ± 0.002)	3.50 ± 0.05 (0.138 ± 0.002)	0.30 ± 0.05 (0.009 ± 0.002)	500
2200	16.0 ± 0.20 (0.630 ± 0.008)	5.35 ± 0.10 (0.211 ± 0.004)	12.0 ± 0.10 (0.472 ± 0.004)	6.10 ± 0.10 (0.240 ± 0.004)	7.50 ± 0.05 (0.295 ± 0.002)	1.75 ± 0.10 (0.069 ± 0.004)	2.00 ± 0.05 (0.079 ± 0.002)	5.50 ± 0.05 (0.217 ± 0.002)	0.35 ± 0.05 (0.009 ± 0.002)	1000

### REEL DIMENSIONS

mm (inches)

Type	ø A	ø B	ø C	W	T
0603	178 ± 2.00 (7.008 ± 0.079)	60.0 ± 0.50 (2.362 ± 0.020)	13.0 ± 0.30 (0.512 ± 0.012)	9.00 ± 0.30 (0.354 ± 0.012)	12.0 ± 1.00 (0.472 ± 0.039)
0805	178 ± 2.00 (7.008 ± 0.079)	60.0 ± 0.50 (2.362 ± 0.020)	13.0 ± 0.30 (0.512 ± 0.012)	9.00 ± 0.30 (0.354 ± 0.012)	12.0 ± 1.00 (0.472 ± 0.039)
1008	178 ± 2.00 (7.008 ± 0.079)	60.0 ± 0.50 (2.362 ± 0.020)	13.0 ± 0.30 (0.512 ± 0.012)	9.00 ± 0.30 (0.354 ± 0.012)	12.0 ± 1.00 (0.472 ± 0.039)
1210	178 ± 2.00 (7.008 ± 0.079)	60.0 ± 0.50 (2.362 ± 0.020)	13.0 ± 0.30 (0.512 ± 0.012)	9.00 ± 0.30 (0.354 ± 0.012)	12.0 ± 1.00 (0.472 ± 0.039)
1812	178 ± 2.00 (7.008 ± 0.079)	80.0 ± 0.50 (3.150 ± 0.020)	13.0 ± 0.30 (0.512 ± 0.012)	13.2 ± 0.30 (0.520 ± 0.012)	16.0 ± 1.00 (0.630 ± 0.039)
2200	330 ± 2.00 (12.99 ± 0.079)	100 ± 0.50 (3.937 ± 0.020)	13.0 ± 0.30 (0.512 ± 0.012)	17.4 ± 0.3 (0.685 ± 0.012)	22.0 ± 1.00 (0.866 ± 0.039)

### LEADER / TRAILER TAPE

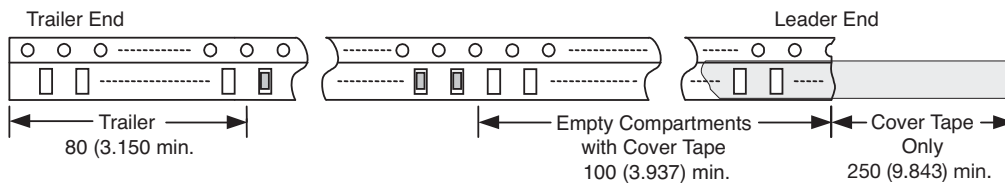

### COVER TAPE PEEL STRENGTH

The force for tearing off cover tape is 0.1~0.6 (N) in the arrow direction at the following conditions:

Temperature: 5~35°C  
 Humidity: 45~85%  
 Atmospheric Pressure: 860~1060 hpa

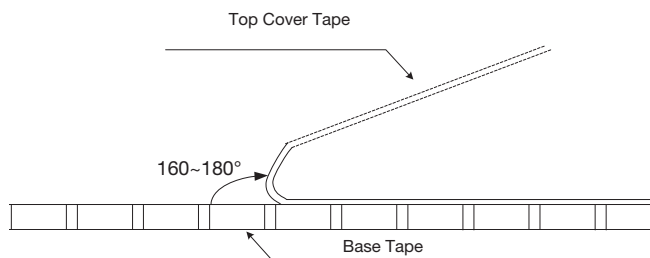

## AMERICAS

AVX Greenville, SC  
Tel: 864-967-2150

## EUROPE

AVX Limited, England  
Tel: +44-1252-770000

AVX S.A.S., France  
Tel: +33-1-69-18-46-00

AVX GmbH, Germany  
Tel: +49-0811-95949-0

AVX SRL, Italy  
Tel: +39-02-614-571

AVX Czech Republic  
Tel: +420-57-57-57-521

AVX/ELCO UK  
Tel: +44-1638-675000

ELCO Europe GmbH  
Tel: +49-2741-299-0

AVX S.A., Spain  
Tel: +34-91-63-97-197

AVX Benelux  
Tel: +31-187-489-337

## ASIA-PACIFIC

AVX/Kyocera (S) Pte Ltd.,  
Singapore  
Tel: +65-6286-7555

AVX/Kyocera, Asia, Ltd.,  
Hong Kong  
Tel: +852-2363-3303

AVX/Kyocera Yuhan Hoesa,  
South Korea  
Tel: +82-2785-6504

AVX/Kyocera HK Ltd.,  
Taiwan  
Tel: +886-2-2656-0258

AVX/Kyocera (M) Sdn Bhd,  
Malaysia  
Tel: +60-4228-1190

AVX/Kyocera International  
Trading Co. Ltd.,  
Shanghai  
Tel: +86-21-3255 1933

AVX/Kyocera Asia Ltd.,  
Shenzen  
Tel: +86-755-3336-0615

AVX/Kyocera International  
Trading Co. Ltd.,  
Beijing  
Tel: +86-10-6588-3528

AVX/Kyocera India  
Liaison Office  
Tel: +91-80-6450-0715

## ASIA-KED

(KYOCERA Electronic Devices)

KED Hong Kong Ltd.  
Tel: +852-2305-1080/1223

KED Hong Kong Ltd.  
Shenzen  
Tel: +86-755-3398-9600

KED Company Ltd.  
Shanghai  
Tel: +86-21-3255-1833

KED Hong Kong Ltd.  
Beijing  
Tel: +86-10-5869-4655

KED Taiwan Ltd.  
Tel: +886-2-2950-0268

KED Korea Yuhan Hoesa,  
South Korea  
Tel: +82-2-783-3604/6126

KED (S) Pte Ltd.  
Singapore  
Tel: +65-6509-0328

Kyocera Corporation  
Japan  
Tel: +81-75-604-3449

### Contact:

